







Assembly code	Assembly description	Assembly image
ASM2093B/0.D01	Cooking chamber	
ASM2094A/0.D00	External cover	
ASM2793A/0.D00	General overview	
ASM4079A/0.D00	Door	
ASM4101A/0.D01	General overview	

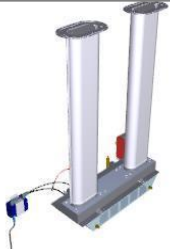

ASM2093B/0.D01 - Cooking chamber

FRONT

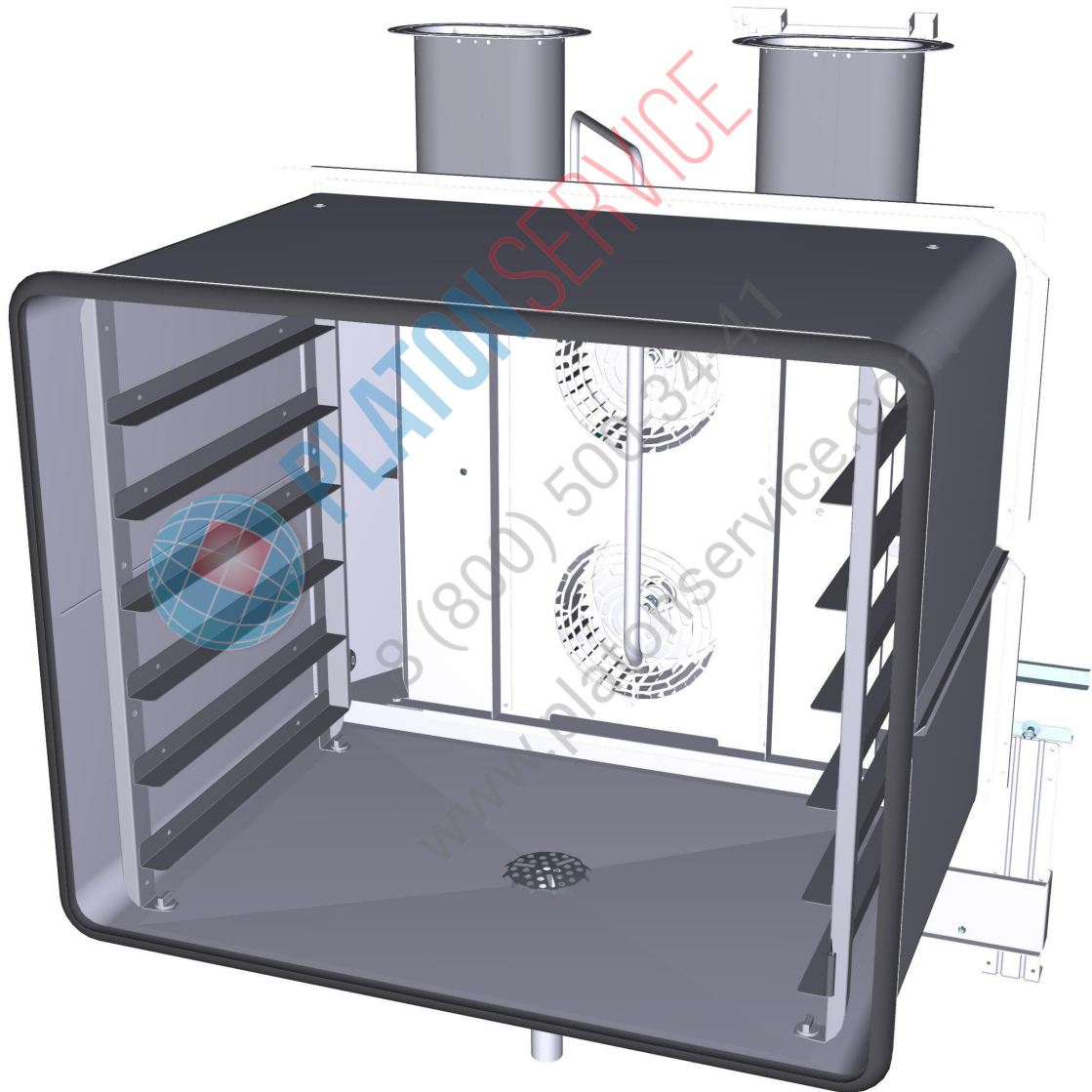

ASM2093B/0.D01 - Cooking chamber

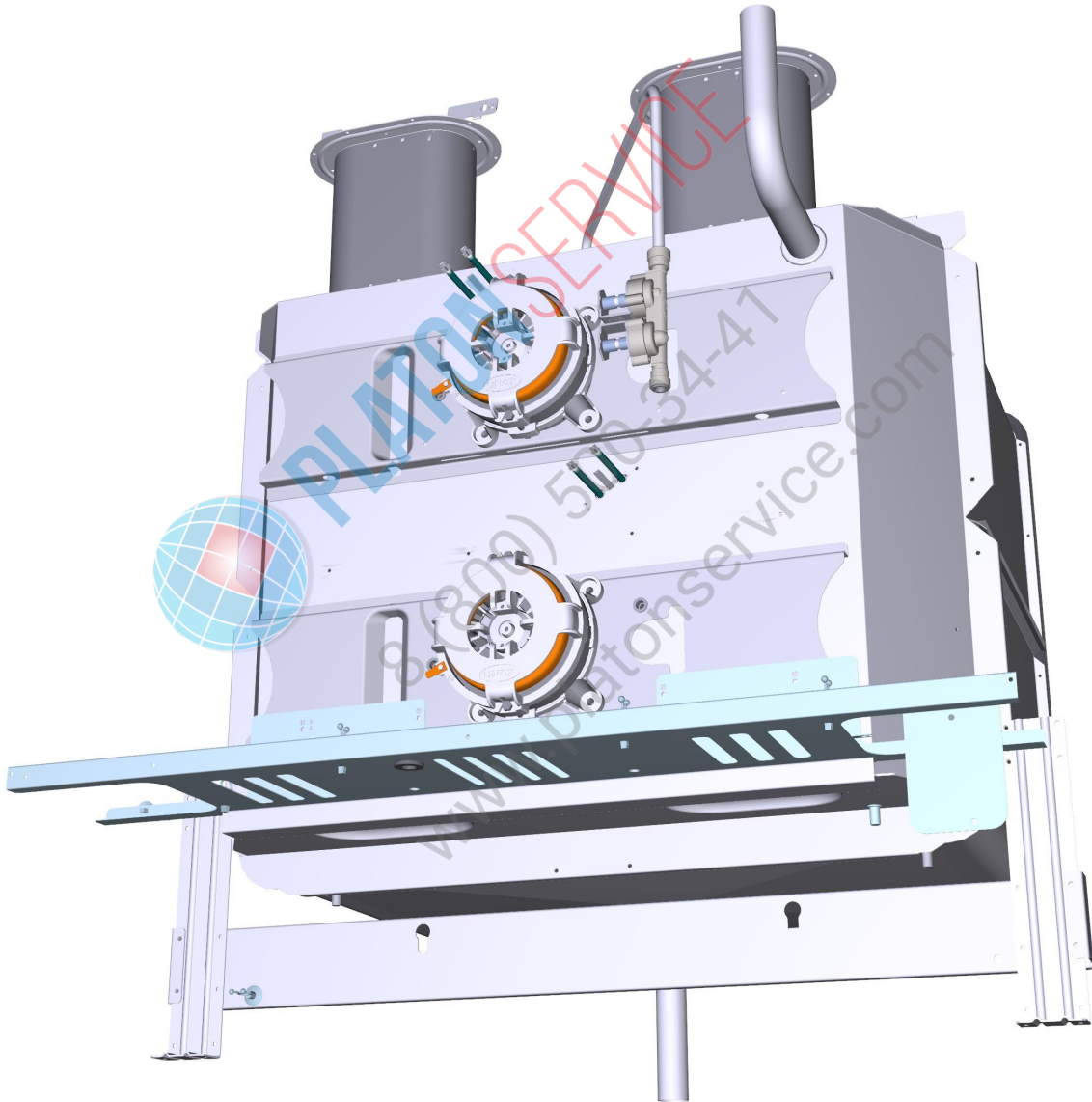

REAR







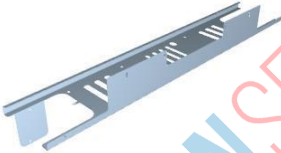
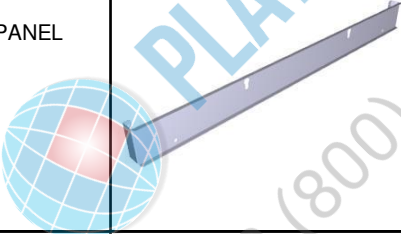

COMPONENT			SPARE PART										
Code	Description	Image	Code	Description	Kit components								
0G1445A	XBC GAS OVENS FAN GUARD SPACE		0G1445A0	XBC GAS OVENS FAN GUARD SPACE									
0G1513A	XBC615EG FAN GUARD		0G1513A0	XBC615EG FAN GUARD									
0H2551A	XBC/XVC ST.STEEL DRAIN COVER		K0H2551A	DRAIN COVER KIT	<table border="1"> <thead> <tr> <th>Code</th> <th>Description</th> <th>Qty</th> <th>UOM</th> </tr> </thead> <tbody> <tr> <td>0H2551A0</td> <td>XBC/XVC ST.STEEL DRAIN COVER</td> <td>1.000</td> <td>PC</td> </tr> </tbody> </table>	Code	Description	Qty	UOM	0H2551A0	XBC/XVC ST.STEEL DRAIN COVER	1.000	PC
Code	Description	Qty	UOM										
0H2551A0	XBC/XVC ST.STEEL DRAIN COVER	1.000	PC										
0H4075A	XBC614/814G GLASS WOOL PRESS PLATE		0H4075A0	XBC614/814G GLASS WOOL PRESS PLATE									
0H4820A	BULB HOLDING BRACKET		0H4820A1	BULB HOLDING BRACKET									



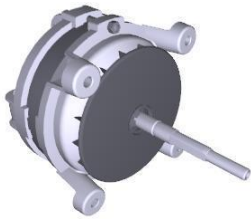

COMPONENT			SPARE PART																						
Code	Description	Image	Code	Description	Kit components																				
0H6334A	BL CL COOKING CHAMBER HOLDING BRACKET		0H6334A0	BL CL COOKING CHAMBER HOLDING BRACKET																					
0H6568C	LUX BURNER SUPPORT PLATE		0H6568C0	LUX BURNER SUPPORT PLATE																					
0H6573A	BURNER LOWER HOLDING PANEL		0H6573A0	BURNER LOWER HOLDING PANEL																					
0H6711B	EXHAUST FUMES THERMOSTAT SUPPORT		0H6711B0	EXHAUST FUMES THERMOSTAT SUPPORT																					
0H4305A	ST. STEEL MOTOR SHAFT SEALING DIS		K0H4305A	SEALING DISC FOR MOTOR SHAFT KIT	<table border="1"> <thead> <tr> <th>Code</th> <th>Description</th> <th>Qty</th> <th>UOM</th> </tr> </thead> <tbody> <tr> <td>0H4305A1</td> <td>ST. STEEL MOTOR SHAFT SEALING DISC</td> <td>1.000</td> <td>PC</td> </tr> <tr> <td>GN1140A3</td> <td>MOLDED MOTOR HOLDER GASKET</td> <td>1.000</td> <td>PC</td> </tr> <tr> <td>SL1045A0</td> <td>S57 BLACK SILICONE - 80ml CARTRIDGE</td> <td>1.000</td> <td>PC</td> </tr> <tr> <td>VI1220A1</td> <td>4,2x12 TCB SELF-TAPPING SCREW</td> <td>3.000</td> <td>PC</td> </tr> </tbody> </table>	Code	Description	Qty	UOM	0H4305A1	ST. STEEL MOTOR SHAFT SEALING DISC	1.000	PC	GN1140A3	MOLDED MOTOR HOLDER GASKET	1.000	PC	SL1045A0	S57 BLACK SILICONE - 80ml CARTRIDGE	1.000	PC	VI1220A1	4,2x12 TCB SELF-TAPPING SCREW	3.000	PC
Code	Description	Qty	UOM																						
0H4305A1	ST. STEEL MOTOR SHAFT SEALING DISC	1.000	PC																						
GN1140A3	MOLDED MOTOR HOLDER GASKET	1.000	PC																						
SL1045A0	S57 BLACK SILICONE - 80ml CARTRIDGE	1.000	PC																						
VI1220A1	4,2x12 TCB SELF-TAPPING SCREW	3.000	PC																						



COMPONENT			SPARE PART																																		
Code	Description	Image	Code	Description	Kit components																																
GN1140A	MOTOR HOLDER GASKET		KGN1140A	5 PCS. MOTOR HOLDER GASKET KI	<table border="1"> <thead> <tr> <th>Code</th> <th>Description</th> <th>Qty</th> <th>UOM</th> </tr> </thead> <tbody> <tr> <td>GN1140A3</td> <td>MOLDED MOTOR HOLDER GASKET</td> <td>5.000</td> <td>PC</td> </tr> </tbody> </table>	Code	Description	Qty	UOM	GN1140A3	MOLDED MOTOR HOLDER GASKET	5.000	PC																								
Code	Description	Qty	UOM																																		
GN1140A3	MOLDED MOTOR HOLDER GASKET	5.000	PC																																		
MT1012A	330W 230V MOTOR		KVN1130A	LUX ≤08.2017/L.MISS/S.5/ 5E MOTOR KIT	<table border="1"> <thead> <tr> <th>Code</th> <th>Description</th> <th>Qty</th> <th>UOM</th> </tr> </thead> <tbody> <tr> <td>0H4305A1</td> <td>ST. STEEL MOTOR SHAFT SEALING DISC</td> <td>1.000</td> <td>PC</td> </tr> <tr> <td>GN1140A3</td> <td>MOLDED MOTOR HOLDER GASKET</td> <td>1.000</td> <td>PC</td> </tr> <tr> <td>VI1034A0</td> <td>STAINLESS STEEL WASHER 8.4x16x1</td> <td>1.000</td> <td>PC</td> </tr> <tr> <td>VI1256A0</td> <td>M8 DIN 980M ST. STEEL SELF LOCKING NUT</td> <td>1.000</td> <td>PC</td> </tr> <tr> <td>VM2196A0</td> <td>MOTOR NUT FASTENING BUSHING</td> <td>1.000</td> <td>PC</td> </tr> <tr> <td>VN1130A1</td> <td>330W 230V 50/60HZ MOTO</td> <td>1.000</td> <td>PC</td> </tr> </tbody> </table>	Code	Description	Qty	UOM	0H4305A1	ST. STEEL MOTOR SHAFT SEALING DISC	1.000	PC	GN1140A3	MOLDED MOTOR HOLDER GASKET	1.000	PC	VI1034A0	STAINLESS STEEL WASHER 8.4x16x1	1.000	PC	VI1256A0	M8 DIN 980M ST. STEEL SELF LOCKING NUT	1.000	PC	VM2196A0	MOTOR NUT FASTENING BUSHING	1.000	PC	VN1130A1	330W 230V 50/60HZ MOTO	1.000	PC				
Code	Description	Qty	UOM																																		
0H4305A1	ST. STEEL MOTOR SHAFT SEALING DISC	1.000	PC																																		
GN1140A3	MOLDED MOTOR HOLDER GASKET	1.000	PC																																		
VI1034A0	STAINLESS STEEL WASHER 8.4x16x1	1.000	PC																																		
VI1256A0	M8 DIN 980M ST. STEEL SELF LOCKING NUT	1.000	PC																																		
VM2196A0	MOTOR NUT FASTENING BUSHING	1.000	PC																																		
VN1130A1	330W 230V 50/60HZ MOTO	1.000	PC																																		
			KMT1012A	LUX >08.2017 / MIND.MAPS 330W MOTOR KIT	<table border="1"> <thead> <tr> <th>Code</th> <th>Description</th> <th>Qty</th> <th>UOM</th> </tr> </thead> <tbody> <tr> <td>0H2842A0</td> <td>MT1012 CENTERING JI</td> <td>1.000</td> <td>PC</td> </tr> <tr> <td>0H4305A1</td> <td>ST. STEEL MOTOR SHAFT SEALING DISC</td> <td>1.000</td> <td>PC</td> </tr> <tr> <td>GN1140A3</td> <td>MOLDED MOTOR HOLDER GASKET</td> <td>1.000</td> <td>PC</td> </tr> <tr> <td>MT1012A0</td> <td>330W 230V MOTOR</td> <td>1.000</td> <td>PC</td> </tr> <tr> <td>VE1550A0</td> <td>5X3 MM NEODYMIUM MAGNET</td> <td>1.000</td> <td>PC</td> </tr> <tr> <td>VI1077A1</td> <td>SCREW M6x12 TE INOX</td> <td>1.000</td> <td>PC</td> </tr> <tr> <td>VI1521A0</td> <td>STAINLESS STEEL WASHER D=6 6592</td> <td>1.000</td> <td>PC</td> </tr> </tbody> </table>	Code	Description	Qty	UOM	0H2842A0	MT1012 CENTERING JI	1.000	PC	0H4305A1	ST. STEEL MOTOR SHAFT SEALING DISC	1.000	PC	GN1140A3	MOLDED MOTOR HOLDER GASKET	1.000	PC	MT1012A0	330W 230V MOTOR	1.000	PC	VE1550A0	5X3 MM NEODYMIUM MAGNET	1.000	PC	VI1077A1	SCREW M6x12 TE INOX	1.000	PC	VI1521A0	STAINLESS STEEL WASHER D=6 6592	1.000	PC
Code	Description	Qty	UOM																																		
0H2842A0	MT1012 CENTERING JI	1.000	PC																																		
0H4305A1	ST. STEEL MOTOR SHAFT SEALING DISC	1.000	PC																																		
GN1140A3	MOLDED MOTOR HOLDER GASKET	1.000	PC																																		
MT1012A0	330W 230V MOTOR	1.000	PC																																		
VE1550A0	5X3 MM NEODYMIUM MAGNET	1.000	PC																																		
VI1077A1	SCREW M6x12 TE INOX	1.000	PC																																		
VI1521A0	STAINLESS STEEL WASHER D=6 6592	1.000	PC																																		

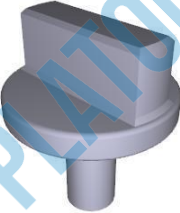

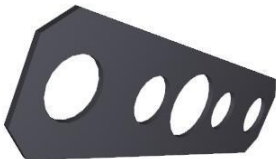
COMPONENT			SPARE PART																						
Code	Description	Image	Code	Description	Kit components																				
MT1012A	330W 230V MOTOR		KMT1012A	LUX >08.2017 / MIND.MAPS 330W MOTOR KIT	<table border="1"> <thead> <tr> <th>Code</th> <th>Description</th> <th>Qty</th> <th>UOM</th> </tr> </thead> <tbody> <tr> <td>VI1966A0</td> <td>M4X14 FLATHEAD SCREW</td> <td>1.000</td> <td>PC</td> </tr> <tr> <td>VM1635A0</td> <td>MAGNET HOLDING DIS</td> <td>1.000</td> <td>PC</td> </tr> </tbody> </table>	Code	Description	Qty	UOM	VI1966A0	M4X14 FLATHEAD SCREW	1.000	PC	VM1635A0	MAGNET HOLDING DIS	1.000	PC								
Code	Description	Qty	UOM																						
VI1966A0	M4X14 FLATHEAD SCREW	1.000	PC																						
VM1635A0	MAGNET HOLDING DIS	1.000	PC																						
VN1181A	M6 NUT 39 BLADES H81 D196 FAN		KVN1181A	D196 H81 39 BLADES FAN+SCREW M6 KIT	<table border="1"> <thead> <tr> <th>Code</th> <th>Description</th> <th>Qty</th> <th>UOM</th> </tr> </thead> <tbody> <tr> <td>VI1077A1</td> <td>SCREW M6x12 TE INOX</td> <td>1.000</td> <td>PC</td> </tr> <tr> <td>VI1521A0</td> <td>STAINLESS STEEL WASHER D=6 6592</td> <td>1.000</td> <td>PC</td> </tr> <tr> <td>VN1181A0</td> <td>M6 NUT 39 BLADES H81 D196 FAN</td> <td>1.000</td> <td>PC</td> </tr> </tbody> </table>	Code	Description	Qty	UOM	VI1077A1	SCREW M6x12 TE INOX	1.000	PC	VI1521A0	STAINLESS STEEL WASHER D=6 6592	1.000	PC	VN1181A0	M6 NUT 39 BLADES H81 D196 FAN	1.000	PC				
Code	Description	Qty	UOM																						
VI1077A1	SCREW M6x12 TE INOX	1.000	PC																						
VI1521A0	STAINLESS STEEL WASHER D=6 6592	1.000	PC																						
VN1181A0	M6 NUT 39 BLADES H81 D196 FAN	1.000	PC																						
			KVN1030A	LUX <=08.2017S.5/S.5E D196 FAN KIT	<table border="1"> <thead> <tr> <th>Code</th> <th>Description</th> <th>Qty</th> <th>UOM</th> </tr> </thead> <tbody> <tr> <td>VI1256A0</td> <td>M8 DIN 980M ST. STEEL SELF LOCKING NUT</td> <td>1.000</td> <td>PC</td> </tr> <tr> <td>VM2196A0</td> <td>MOTOR NUT FASTENING BUSHING</td> <td>1.000</td> <td>PC</td> </tr> <tr> <td>VN1030A5</td> <td>Ø196 H81 38 BLADES MOTOR FAN</td> <td>1.000</td> <td>PC</td> </tr> </tbody> </table>	Code	Description	Qty	UOM	VI1256A0	M8 DIN 980M ST. STEEL SELF LOCKING NUT	1.000	PC	VM2196A0	MOTOR NUT FASTENING BUSHING	1.000	PC	VN1030A5	Ø196 H81 38 BLADES MOTOR FAN	1.000	PC				
Code	Description	Qty	UOM																						
VI1256A0	M8 DIN 980M ST. STEEL SELF LOCKING NUT	1.000	PC																						
VM2196A0	MOTOR NUT FASTENING BUSHING	1.000	PC																						
VN1030A5	Ø196 H81 38 BLADES MOTOR FAN	1.000	PC																						
GRL1267A	LEFT LATERAL SUPPORT 6x600x40		KGRL1267A	6TRAYS 60X40 LATERAL SUPPORT KIT	<table border="1"> <thead> <tr> <th>Code</th> <th>Description</th> <th>Qty</th> <th>UOM</th> </tr> </thead> <tbody> <tr> <td>0H6585A1</td> <td>0H4380A+0H4 381A FLAT SUPPORTING PROFILE</td> <td>1.000</td> <td>PC</td> </tr> <tr> <td>0H6586A1</td> <td>0H4385A+0H4 386A FLAT SUPPORTING PROFILE</td> <td>1.000</td> <td>PC</td> </tr> <tr> <td>GRL1267A0</td> <td>LEFT LATERAL SUPPORT 6x600x400</td> <td>1.000</td> <td>PC</td> </tr> <tr> <td>GRL1268A0</td> <td>RIGHT LATERAL SUPPORT 6x600x400</td> <td>1.000</td> <td>PC</td> </tr> </tbody> </table>	Code	Description	Qty	UOM	0H6585A1	0H4380A+0H4 381A FLAT SUPPORTING PROFILE	1.000	PC	0H6586A1	0H4385A+0H4 386A FLAT SUPPORTING PROFILE	1.000	PC	GRL1267A0	LEFT LATERAL SUPPORT 6x600x400	1.000	PC	GRL1268A0	RIGHT LATERAL SUPPORT 6x600x400	1.000	PC
Code	Description	Qty	UOM																						
0H6585A1	0H4380A+0H4 381A FLAT SUPPORTING PROFILE	1.000	PC																						
0H6586A1	0H4385A+0H4 386A FLAT SUPPORTING PROFILE	1.000	PC																						
GRL1267A0	LEFT LATERAL SUPPORT 6x600x400	1.000	PC																						
GRL1268A0	RIGHT LATERAL SUPPORT 6x600x400	1.000	PC																						

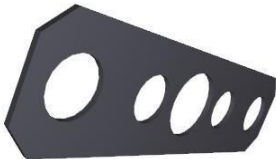

COMPONENT			SPARE PART																						
Code	Description	Image	Code	Description	Kit components																				
GRL1268A	RIGHT LATERAL SUPPORT 6x600x40		KGRL1267A	6TRAYS 60X40 LATERAL SUPPORT KIT	<table border="1"> <thead> <tr> <th>Code</th> <th>Description</th> <th>Qty</th> <th>UOM</th> </tr> </thead> <tbody> <tr> <td>0H6585A1</td> <td>0H4380A+0H4 381A FLAT SUPPORTING PROFILE</td> <td>1.000</td> <td>PC</td> </tr> <tr> <td>0H6586A1</td> <td>0H4385A+0H4 386A FLAT SUPPORTING PROFILE</td> <td>1.000</td> <td>PC</td> </tr> <tr> <td>GRL1267A0</td> <td>LEFT LATERAL SUPPORT 6x600x400</td> <td>1.000</td> <td>PC</td> </tr> <tr> <td>GRL1268A0</td> <td>RIGHT LATERAL SUPPORT 6x600x400</td> <td>1.000</td> <td>PC</td> </tr> </tbody> </table>	Code	Description	Qty	UOM	0H6585A1	0H4380A+0H4 381A FLAT SUPPORTING PROFILE	1.000	PC	0H6586A1	0H4385A+0H4 386A FLAT SUPPORTING PROFILE	1.000	PC	GRL1267A0	LEFT LATERAL SUPPORT 6x600x400	1.000	PC	GRL1268A0	RIGHT LATERAL SUPPORT 6x600x400	1.000	PC
Code	Description	Qty	UOM																						
0H6585A1	0H4380A+0H4 381A FLAT SUPPORTING PROFILE	1.000	PC																						
0H6586A1	0H4385A+0H4 386A FLAT SUPPORTING PROFILE	1.000	PC																						
GRL1267A0	LEFT LATERAL SUPPORT 6x600x400	1.000	PC																						
GRL1268A0	RIGHT LATERAL SUPPORT 6x600x400	1.000	PC																						
VM1820A	LATERAL SUPPORTS M6 FIXING BOLT		KVM1820A	THUMB SCREW 10PCS KIT	<table border="1"> <thead> <tr> <th>Code</th> <th>Description</th> <th>Qty</th> <th>UOM</th> </tr> </thead> <tbody> <tr> <td>VM1820A0</td> <td>LATERAL SUPPORTS M6 FIXING BOLT</td> <td>10.000</td> <td>PC</td> </tr> </tbody> </table>	Code	Description	Qty	UOM	VM1820A0	LATERAL SUPPORTS M6 FIXING BOLT	10.000	PC												
Code	Description	Qty	UOM																						
VM1820A0	LATERAL SUPPORTS M6 FIXING BOLT	10.000	PC																						
EL1361A	D8-D10 J.G. STEAM SOLENOID VALVE		KEL1361A	JG D8-D10 5+9 STEAM SOLENOID VALVE KIT	<table border="1"> <thead> <tr> <th>Code</th> <th>Description</th> <th>Qty</th> <th>UOM</th> </tr> </thead> <tbody> <tr> <td>EL1361A0</td> <td>D8-D10 J.G. STEAM SOLENOID VALVE</td> <td>1.000</td> <td>PC</td> </tr> </tbody> </table>	Code	Description	Qty	UOM	EL1361A0	D8-D10 J.G. STEAM SOLENOID VALVE	1.000	PC												
Code	Description	Qty	UOM																						
EL1361A0	D8-D10 J.G. STEAM SOLENOID VALVE	1.000	PC																						
GN1326A	ELEMENT SEALING		KRS1274A	100W MOTOR BRAKING ELEMENT KIT	<table border="1"> <thead> <tr> <th>Code</th> <th>Description</th> <th>Qty</th> <th>UOM</th> </tr> </thead> <tbody> <tr> <td>GN1672A1</td> <td>BREAKING ELEMENT GASKET</td> <td>1.000</td> <td>PC</td> </tr> <tr> <td>RS1274A0</td> <td>100W 60V 1 TURN FLAT ELEMENT</td> <td>1.000</td> <td>PC</td> </tr> <tr> <td>SL1045A0</td> <td>S57 BLACK SILICONE - 80ml CARTRIDGE</td> <td>1.000</td> <td>PC</td> </tr> <tr> <td>VI1220A1</td> <td>4,2x12 TCB SELF-TAPPING SCREW</td> <td>2.000</td> <td>PC</td> </tr> </tbody> </table>	Code	Description	Qty	UOM	GN1672A1	BREAKING ELEMENT GASKET	1.000	PC	RS1274A0	100W 60V 1 TURN FLAT ELEMENT	1.000	PC	SL1045A0	S57 BLACK SILICONE - 80ml CARTRIDGE	1.000	PC	VI1220A1	4,2x12 TCB SELF-TAPPING SCREW	2.000	PC
Code	Description	Qty	UOM																						
GN1672A1	BREAKING ELEMENT GASKET	1.000	PC																						
RS1274A0	100W 60V 1 TURN FLAT ELEMENT	1.000	PC																						
SL1045A0	S57 BLACK SILICONE - 80ml CARTRIDGE	1.000	PC																						
VI1220A1	4,2x12 TCB SELF-TAPPING SCREW	2.000	PC																						

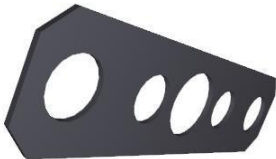
COMPONENT			SPARE PART																						
Code	Description	Image	Code	Description	Kit components																				
GN1326A	ELEMENT SEALING		KRS1261A	122W MOTOR BREAKING ELEMENT KIT	<table border="1"> <thead> <tr> <th>Code</th> <th>Description</th> <th>Qty</th> <th>UOM</th> </tr> </thead> <tbody> <tr> <td>GN1326A1</td> <td>ELEMENT SEALING</td> <td>1.000</td> <td>PC</td> </tr> <tr> <td>RS1261A0</td> <td>BAKERLUXCH EFLUX MOTOR BREAKING ELEMENT</td> <td>1.000</td> <td>PC</td> </tr> <tr> <td>SL1045A0</td> <td>S57 BLACK SILICONE - 80ml CARTRIDGE</td> <td>1.000</td> <td>PC</td> </tr> <tr> <td>VI1220A1</td> <td>4,2x12 TCB SELF-TAPPIN G SCREW</td> <td>2.000</td> <td>PC</td> </tr> </tbody> </table>	Code	Description	Qty	UOM	GN1326A1	ELEMENT SEALING	1.000	PC	RS1261A0	BAKERLUXCH EFLUX MOTOR BREAKING ELEMENT	1.000	PC	SL1045A0	S57 BLACK SILICONE - 80ml CARTRIDGE	1.000	PC	VI1220A1	4,2x12 TCB SELF-TAPPIN G SCREW	2.000	PC
			Code	Description	Qty	UOM																			
			GN1326A1	ELEMENT SEALING	1.000	PC																			
			RS1261A0	BAKERLUXCH EFLUX MOTOR BREAKING ELEMENT	1.000	PC																			
SL1045A0	S57 BLACK SILICONE - 80ml CARTRIDGE	1.000	PC																						
VI1220A1	4,2x12 TCB SELF-TAPPIN G SCREW	2.000	PC																						
KRS1215A	147W MOTOR BRAKING ELEMENT KIT	<table border="1"> <thead> <tr> <th>Code</th> <th>Description</th> <th>Qty</th> <th>UOM</th> </tr> </thead> <tbody> <tr> <td>GN1672A1</td> <td>BREAKING ELEMENT GASKET</td> <td>1.000</td> <td>PC</td> </tr> <tr> <td>RS1215A1</td> <td>147W 105V BRAKING ELEMENT</td> <td>1.000</td> <td>PC</td> </tr> <tr> <td>SL1045A0</td> <td>S57 BLACK SILICONE - 80ml CARTRIDGE</td> <td>1.000</td> <td>PC</td> </tr> <tr> <td>VI1220A1</td> <td>4,2x12 TCB SELF-TAPPIN G SCREW</td> <td>2.000</td> <td>PC</td> </tr> </tbody> </table>	Code	Description	Qty	UOM	GN1672A1	BREAKING ELEMENT GASKET	1.000	PC	RS1215A1	147W 105V BRAKING ELEMENT	1.000	PC	SL1045A0	S57 BLACK SILICONE - 80ml CARTRIDGE	1.000	PC	VI1220A1	4,2x12 TCB SELF-TAPPIN G SCREW	2.000	PC			
Code	Description	Qty	UOM																						
GN1672A1	BREAKING ELEMENT GASKET	1.000	PC																						
RS1215A1	147W 105V BRAKING ELEMENT	1.000	PC																						
SL1045A0	S57 BLACK SILICONE - 80ml CARTRIDGE	1.000	PC																						
VI1220A1	4,2x12 TCB SELF-TAPPIN G SCREW	2.000	PC																						
KRS1095A	1.2KW HEATING ELEMENT KIT	<table border="1"> <thead> <tr> <th>Code</th> <th>Description</th> <th>Qty</th> <th>UOM</th> </tr> </thead> <tbody> <tr> <td>GN1326A1</td> <td>ELEMENT SEALING</td> <td>1.000</td> <td>PC</td> </tr> <tr> <td>RS1095A1</td> <td>HEATING ELEMENT 1200W 230V</td> <td>1.000</td> <td>PC</td> </tr> <tr> <td>SL1045A0</td> <td>S57 BLACK SILICONE - 80ml CARTRIDGE</td> <td>1.000</td> <td>PC</td> </tr> <tr> <td>VI1220A1</td> <td>4,2x12 TCB SELF-TAPPIN G SCREW</td> <td>2.000</td> <td>PC</td> </tr> </tbody> </table>	Code	Description	Qty	UOM	GN1326A1	ELEMENT SEALING	1.000	PC	RS1095A1	HEATING ELEMENT 1200W 230V	1.000	PC	SL1045A0	S57 BLACK SILICONE - 80ml CARTRIDGE	1.000	PC	VI1220A1	4,2x12 TCB SELF-TAPPIN G SCREW	2.000	PC			
Code	Description	Qty	UOM																						
GN1326A1	ELEMENT SEALING	1.000	PC																						
RS1095A1	HEATING ELEMENT 1200W 230V	1.000	PC																						
SL1045A0	S57 BLACK SILICONE - 80ml CARTRIDGE	1.000	PC																						
VI1220A1	4,2x12 TCB SELF-TAPPIN G SCREW	2.000	PC																						
KRS1012A	1365W 120V HEATING ELEMENT KIT	<table border="1"> <thead> <tr> <th>Code</th> <th>Description</th> <th>Qty</th> <th>UOM</th> </tr> </thead> <tbody> <tr> <td>GN1326A1</td> <td>ELEMENT SEALING</td> <td>1.000</td> <td>PC</td> </tr> <tr> <td>RS1012A0</td> <td>CIRCULAR ELEMENT 1365W 120V</td> <td>1.000</td> <td>PC</td> </tr> <tr> <td>VI1220A1</td> <td>4,2x12 TCB SELF-TAPPIN G SCREW</td> <td>5.000</td> <td>PC</td> </tr> </tbody> </table>	Code	Description	Qty	UOM	GN1326A1	ELEMENT SEALING	1.000	PC	RS1012A0	CIRCULAR ELEMENT 1365W 120V	1.000	PC	VI1220A1	4,2x12 TCB SELF-TAPPIN G SCREW	5.000	PC							
Code	Description	Qty	UOM																						
GN1326A1	ELEMENT SEALING	1.000	PC																						
RS1012A0	CIRCULAR ELEMENT 1365W 120V	1.000	PC																						
VI1220A1	4,2x12 TCB SELF-TAPPIN G SCREW	5.000	PC																						

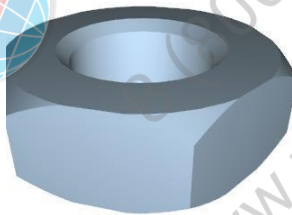

COMPONENT			SPARE PART																														
Code	Description	Image	Code	Description	Kit components																												
GN1326A	ELEMENT SEALING		KRS1011A	ROBERTA/LISA HEATING ELEMENT KIT	<table border="1"> <thead> <tr> <th>Code</th> <th>Description</th> <th>Qty</th> <th>UOM</th> </tr> </thead> <tbody> <tr> <td>GN1326A1</td> <td>ELEMENT SEALING</td> <td>1.000</td> <td>PC</td> </tr> <tr> <td>RS1011A0</td> <td>2560W 220-230V HEATING ELEMENT</td> <td>1.000</td> <td>PC</td> </tr> <tr> <td>SL1045A0</td> <td>S57 BLACK SILICONE - 80ml CARTRIDGE</td> <td>1.000</td> <td>PC</td> </tr> <tr> <td>VI1220A1</td> <td>4,2x12 TCB SELF-TAPPIN G SCREW</td> <td>5.000</td> <td>PC</td> </tr> <tr> <td>VM1794A0</td> <td>250x4.8 PA66 BLACK CLAMP</td> <td>2.000</td> <td>PC</td> </tr> <tr> <td>VM2103A0</td> <td>CLAMP LOCK</td> <td>2.000</td> <td>PC</td> </tr> </tbody> </table>	Code	Description	Qty	UOM	GN1326A1	ELEMENT SEALING	1.000	PC	RS1011A0	2560W 220-230V HEATING ELEMENT	1.000	PC	SL1045A0	S57 BLACK SILICONE - 80ml CARTRIDGE	1.000	PC	VI1220A1	4,2x12 TCB SELF-TAPPIN G SCREW	5.000	PC	VM1794A0	250x4.8 PA66 BLACK CLAMP	2.000	PC	VM2103A0	CLAMP LOCK	2.000	PC
			Code	Description	Qty	UOM																											
			GN1326A1	ELEMENT SEALING	1.000	PC																											
RS1011A0	2560W 220-230V HEATING ELEMENT	1.000	PC																														
SL1045A0	S57 BLACK SILICONE - 80ml CARTRIDGE	1.000	PC																														
VI1220A1	4,2x12 TCB SELF-TAPPIN G SCREW	5.000	PC																														
VM1794A0	250x4.8 PA66 BLACK CLAMP	2.000	PC																														
VM2103A0	CLAMP LOCK	2.000	PC																														
KRS0090A	HEATING ELEMENT 1.26kW	<table border="1"> <thead> <tr> <th>Code</th> <th>Description</th> <th>Qty</th> <th>UOM</th> </tr> </thead> <tbody> <tr> <td>GN1326A1</td> <td>ELEMENT SEALING</td> <td>1.000</td> <td>PC</td> </tr> <tr> <td>RS0090A0</td> <td>CIRC. HEAT. ELEMENT 1260W 220-230</td> <td>1.000</td> <td>PC</td> </tr> <tr> <td>VI1220A1</td> <td>4,2x12 TCB SELF-TAPPIN G SCREW</td> <td>3.000</td> <td>PC</td> </tr> <tr> <td>VM1794A0</td> <td>250x4.8 PA66 BLACK CLAMP</td> <td>2.000</td> <td>PC</td> </tr> <tr> <td>VM2103A0</td> <td>CLAMP LOCK</td> <td>2.000</td> <td>PC</td> </tr> </tbody> </table>	Code	Description	Qty	UOM	GN1326A1	ELEMENT SEALING	1.000	PC	RS0090A0	CIRC. HEAT. ELEMENT 1260W 220-230	1.000	PC	VI1220A1	4,2x12 TCB SELF-TAPPIN G SCREW	3.000	PC	VM1794A0	250x4.8 PA66 BLACK CLAMP	2.000	PC	VM2103A0	CLAMP LOCK	2.000	PC							
Code	Description	Qty	UOM																														
GN1326A1	ELEMENT SEALING	1.000	PC																														
RS0090A0	CIRC. HEAT. ELEMENT 1260W 220-230	1.000	PC																														
VI1220A1	4,2x12 TCB SELF-TAPPIN G SCREW	3.000	PC																														
VM1794A0	250x4.8 PA66 BLACK CLAMP	2.000	PC																														
VM2103A0	CLAMP LOCK	2.000	PC																														
KRS0050A	HEATING ELEMENT KIT 0.5kW	<table border="1"> <thead> <tr> <th>Code</th> <th>Description</th> <th>Qty</th> <th>UOM</th> </tr> </thead> <tbody> <tr> <td>GN1326A1</td> <td>ELEMENT SEALING</td> <td>1.000</td> <td>PC</td> </tr> <tr> <td>RS0050A0</td> <td>HEAT. ELEMENT 500W 220-230V LIEV</td> <td>1.000</td> <td>PC</td> </tr> <tr> <td>VI1220A1</td> <td>4,2x12 TCB SELF-TAPPIN G SCREW</td> <td>2.000</td> <td>PC</td> </tr> </tbody> </table>	Code	Description	Qty	UOM	GN1326A1	ELEMENT SEALING	1.000	PC	RS0050A0	HEAT. ELEMENT 500W 220-230V LIEV	1.000	PC	VI1220A1	4,2x12 TCB SELF-TAPPIN G SCREW	2.000	PC															
Code	Description	Qty	UOM																														
GN1326A1	ELEMENT SEALING	1.000	PC																														
RS0050A0	HEAT. ELEMENT 500W 220-230V LIEV	1.000	PC																														
VI1220A1	4,2x12 TCB SELF-TAPPIN G SCREW	2.000	PC																														
KRS0011A	HEATING ELEMENT 1.465kW RS0011A	<table border="1"> <thead> <tr> <th>Code</th> <th>Description</th> <th>Qty</th> <th>UOM</th> </tr> </thead> <tbody> <tr> <td>GN1326A1</td> <td>ELEMENT SEALING</td> <td>1.000</td> <td>PC</td> </tr> <tr> <td>RS0011A0</td> <td>CIRC.HEAT. ELEMENT 1465W 220-230</td> <td>1.000</td> <td>PC</td> </tr> <tr> <td>VI1220A1</td> <td>4,2x12 TCB SELF-TAPPIN G SCREW</td> <td>3.000</td> <td>PC</td> </tr> <tr> <td>VM1794A0</td> <td>250x4.8 PA66 BLACK CLAMP</td> <td>2.000</td> <td>PC</td> </tr> <tr> <td>VM2103A0</td> <td>CLAMP LOCK</td> <td>2.000</td> <td>PC</td> </tr> </tbody> </table>	Code	Description	Qty	UOM	GN1326A1	ELEMENT SEALING	1.000	PC	RS0011A0	CIRC.HEAT. ELEMENT 1465W 220-230	1.000	PC	VI1220A1	4,2x12 TCB SELF-TAPPIN G SCREW	3.000	PC	VM1794A0	250x4.8 PA66 BLACK CLAMP	2.000	PC	VM2103A0	CLAMP LOCK	2.000	PC							
Code	Description	Qty	UOM																														
GN1326A1	ELEMENT SEALING	1.000	PC																														
RS0011A0	CIRC.HEAT. ELEMENT 1465W 220-230	1.000	PC																														
VI1220A1	4,2x12 TCB SELF-TAPPIN G SCREW	3.000	PC																														
VM1794A0	250x4.8 PA66 BLACK CLAMP	2.000	PC																														
VM2103A0	CLAMP LOCK	2.000	PC																														

COMPONENT			SPARE PART																						
Code	Description	Image	Code	Description	Kit components																				
GN1326A	ELEMENT SEALING		KRS0010A	KIT HEATING ELEMENT RS10010A	<table border="1"> <thead> <tr> <th>Code</th> <th>Description</th> <th>Qty</th> <th>UOM</th> </tr> </thead> <tbody> <tr> <td>GN1326A1</td> <td>ELEMENT SEALING</td> <td>1.000</td> <td>PC</td> </tr> <tr> <td>RS0010A0</td> <td>CIRC.HEAT. ELEMENT 2560W - 220-230 V</td> <td>1.000</td> <td>PC</td> </tr> <tr> <td>VI1220A1</td> <td>4,2x12 TCB SELF-TAPPIN G SCREW</td> <td>3.000</td> <td>PC</td> </tr> </tbody> </table>	Code	Description	Qty	UOM	GN1326A1	ELEMENT SEALING	1.000	PC	RS0010A0	CIRC.HEAT. ELEMENT 2560W - 220-230 V	1.000	PC	VI1220A1	4,2x12 TCB SELF-TAPPIN G SCREW	3.000	PC				
			Code	Description	Qty	UOM																			
GN1326A1	ELEMENT SEALING	1.000	PC																						
RS0010A0	CIRC.HEAT. ELEMENT 2560W - 220-230 V	1.000	PC																						
VI1220A1	4,2x12 TCB SELF-TAPPIN G SCREW	3.000	PC																						
KG1326A	HEATING ELEMENT GASKET 5 PCS KIT	<table border="1"> <thead> <tr> <th>Code</th> <th>Description</th> <th>Qty</th> <th>UOM</th> </tr> </thead> <tbody> <tr> <td>GN1326A1</td> <td>ELEMENT SEALING</td> <td>5.000</td> <td>PC</td> </tr> </tbody> </table>	Code	Description	Qty	UOM	GN1326A1	ELEMENT SEALING	5.000	PC															
Code	Description	Qty	UOM																						
GN1326A1	ELEMENT SEALING	5.000	PC																						
GN1342C	XBC605E DOOR GASKET - GN1006A		KGN1663A	600-1200 SERIES/CL 500 DOOR GASKET KIT	<table border="1"> <thead> <tr> <th>Code</th> <th>Description</th> <th>Qty</th> <th>UOM</th> </tr> </thead> <tbody> <tr> <td>GN1626A0</td> <td>DOUBLE LIP-TYPE FRONT GASKE</td> <td>2.510</td> <td>M</td> </tr> <tr> <td>SL1025A0</td> <td>CLEAR SILICON DOW CORNING 734</td> <td>0.012</td> <td>PC</td> </tr> <tr> <td>VM2277A0</td> <td>DOOR SEAL KIT INTERNAL CONNECTION</td> <td>1.000</td> <td>PC</td> </tr> </tbody> </table>	Code	Description	Qty	UOM	GN1626A0	DOUBLE LIP-TYPE FRONT GASKE	2.510	M	SL1025A0	CLEAR SILICON DOW CORNING 734	0.012	PC	VM2277A0	DOOR SEAL KIT INTERNAL CONNECTION	1.000	PC				
					Code	Description	Qty	UOM																	
					GN1626A0	DOUBLE LIP-TYPE FRONT GASKE	2.510	M																	
SL1025A0	CLEAR SILICON DOW CORNING 734	0.012	PC																						
VM2277A0	DOOR SEAL KIT INTERNAL CONNECTION	1.000	PC																						
RC1170A	M14 H=7 CH=22 STAINLESS STEEL NUT		KRC1170A	M14 H8 CH22 NUT - 10 PCS. KIT	<table border="1"> <thead> <tr> <th>Code</th> <th>Description</th> <th>Qty</th> <th>UOM</th> </tr> </thead> <tbody> <tr> <td>RC1170A1</td> <td>M14 H=7 CH=22 STAINLESS STEEL NUT</td> <td>10.000</td> <td>PC</td> </tr> </tbody> </table>	Code	Description	Qty	UOM	RC1170A1	M14 H=7 CH=22 STAINLESS STEEL NUT	10.000	PC												
Code	Description	Qty	UOM																						
RC1170A1	M14 H=7 CH=22 STAINLESS STEEL NUT	10.000	PC																						
RS1261A	BAKERLUXCHEFLUX MOTOR BREAKING ELEMEN		KRS1261A	122W MOTOR BREAKING ELEMENT KIT	<table border="1"> <thead> <tr> <th>Code</th> <th>Description</th> <th>Qty</th> <th>UOM</th> </tr> </thead> <tbody> <tr> <td>GN1326A1</td> <td>ELEMENT SEALING</td> <td>1.000</td> <td>PC</td> </tr> <tr> <td>RS1261A0</td> <td>BAKERLUXCH EFLUX MOTOR BREAKING ELEMENT</td> <td>1.000</td> <td>PC</td> </tr> <tr> <td>SL1045A0</td> <td>S57 BLACK SILICONE - 80ml CARTRIDGE</td> <td>1.000</td> <td>PC</td> </tr> <tr> <td>VI1220A1</td> <td>4,2x12 TCB SELF-TAPPIN G SCREW</td> <td>2.000</td> <td>PC</td> </tr> </tbody> </table>	Code	Description	Qty	UOM	GN1326A1	ELEMENT SEALING	1.000	PC	RS1261A0	BAKERLUXCH EFLUX MOTOR BREAKING ELEMENT	1.000	PC	SL1045A0	S57 BLACK SILICONE - 80ml CARTRIDGE	1.000	PC	VI1220A1	4,2x12 TCB SELF-TAPPIN G SCREW	2.000	PC
					Code	Description	Qty	UOM																	
					GN1326A1	ELEMENT SEALING	1.000	PC																	
					RS1261A0	BAKERLUXCH EFLUX MOTOR BREAKING ELEMENT	1.000	PC																	
SL1045A0	S57 BLACK SILICONE - 80ml CARTRIDGE	1.000	PC																						
VI1220A1	4,2x12 TCB SELF-TAPPIN G SCREW	2.000	PC																						

COMPONENT			SPARE PART																						
Code	Description	Image	Code	Description	Kit components																				
TB1515A	EXTERNAL HUMIDITY PIPE + RC1165A0		TB1515A1	EXTERNAL HUMIDITY PIPE + RC1165A0																					
VM1465A	CT BT TEMPERATURE PROBE COVER		KTR1150B	PT1000 L1200 TEMPERATURE PROBE KIT	<table border="1"> <thead> <tr> <th>Code</th> <th>Description</th> <th>Qty</th> <th>UOM</th> </tr> </thead> <tbody> <tr> <td>GN1285A0</td> <td>NTC TEMPERATUR E PROBE SEALING</td> <td>1.000</td> <td>PC</td> </tr> <tr> <td>TR1150B1</td> <td>CL.A L1200 46L2 PT1000 TEMPERATUR E PROBE</td> <td>1.000</td> <td>PC</td> </tr> <tr> <td>VI1220A1</td> <td>4,2x12 TCB SELF-TAPPIN G SCREW</td> <td>1.000</td> <td>PC</td> </tr> <tr> <td>VM1465A1</td> <td>CT BT TEMPERATUR E PROBE COVER</td> <td>1.000</td> <td>PC</td> </tr> </tbody> </table>	Code	Description	Qty	UOM	GN1285A0	NTC TEMPERATUR E PROBE SEALING	1.000	PC	TR1150B1	CL.A L1200 46L2 PT1000 TEMPERATUR E PROBE	1.000	PC	VI1220A1	4,2x12 TCB SELF-TAPPIN G SCREW	1.000	PC	VM1465A1	CT BT TEMPERATUR E PROBE COVER	1.000	PC
Code	Description	Qty	UOM																						
GN1285A0	NTC TEMPERATUR E PROBE SEALING	1.000	PC																						
TR1150B1	CL.A L1200 46L2 PT1000 TEMPERATUR E PROBE	1.000	PC																						
VI1220A1	4,2x12 TCB SELF-TAPPIN G SCREW	1.000	PC																						
VM1465A1	CT BT TEMPERATUR E PROBE COVER	1.000	PC																						
			KTR1150A	EVEREO PT100 L2000 TEMPERATURE PROBE KIT	<table border="1"> <thead> <tr> <th>Code</th> <th>Description</th> <th>Qty</th> <th>UOM</th> </tr> </thead> <tbody> <tr> <td>CE1880A0</td> <td>CPM 4P 3P81 CONNECTION CABLE EXIT 90</td> <td>1.000</td> <td>PC</td> </tr> <tr> <td>GN1285A0</td> <td>NTC TEMPERATUR E PROBE SEALING</td> <td>1.000</td> <td>PC</td> </tr> <tr> <td>TR1150A0</td> <td>PT100 3F L2000 TEMPERATUR E PROBE</td> <td>1.000</td> <td>PC</td> </tr> <tr> <td>VM1465A1</td> <td>CT BT TEMPERATUR E PROBE COVER</td> <td>1.000</td> <td>PC</td> </tr> </tbody> </table>	Code	Description	Qty	UOM	CE1880A0	CPM 4P 3P81 CONNECTION CABLE EXIT 90	1.000	PC	GN1285A0	NTC TEMPERATUR E PROBE SEALING	1.000	PC	TR1150A0	PT100 3F L2000 TEMPERATUR E PROBE	1.000	PC	VM1465A1	CT BT TEMPERATUR E PROBE COVER	1.000	PC
Code	Description	Qty	UOM																						
CE1880A0	CPM 4P 3P81 CONNECTION CABLE EXIT 90	1.000	PC																						
GN1285A0	NTC TEMPERATUR E PROBE SEALING	1.000	PC																						
TR1150A0	PT100 3F L2000 TEMPERATUR E PROBE	1.000	PC																						
VM1465A1	CT BT TEMPERATUR E PROBE COVER	1.000	PC																						
			KTR1106B	MIND.Maps L2000 CHAMBER TEMP. PROBE KIT	<table border="1"> <thead> <tr> <th>Code</th> <th>Description</th> <th>Qty</th> <th>UOM</th> </tr> </thead> <tbody> <tr> <td>GN1285A0</td> <td>NTC TEMPERATUR E PROBE SEALING</td> <td>1.000</td> <td>PC</td> </tr> <tr> <td>SL1045A0</td> <td>S57 BLACK SILICONE - 80ml CARTRIDGE</td> <td>1.000</td> <td>PC</td> </tr> </tbody> </table>	Code	Description	Qty	UOM	GN1285A0	NTC TEMPERATUR E PROBE SEALING	1.000	PC	SL1045A0	S57 BLACK SILICONE - 80ml CARTRIDGE	1.000	PC								
Code	Description	Qty	UOM																						
GN1285A0	NTC TEMPERATUR E PROBE SEALING	1.000	PC																						
SL1045A0	S57 BLACK SILICONE - 80ml CARTRIDGE	1.000	PC																						



COMPONENT			SPARE PART																							
Code	Description	Image	Code	Description	Kit components																					
VM1465A	CT BT TEMPERATURE PROBE COVER		KTR1106B	MIND.Maps L2000 CHAMBER TEMP. PROBE KIT	<table border="1"> <thead> <tr> <th>Code</th> <th>Description</th> <th>Qty</th> <th>UOM</th> </tr> </thead> <tbody> <tr> <td>TR1106B0</td> <td>PT100 L=2000 TEMPERATUR E PROBE</td> <td>1.000</td> <td>PC</td> </tr> <tr> <td>VI1220A1</td> <td>4,2x12 TCB SELF-TAPPIN G SCREW</td> <td>2.000</td> <td>PC</td> </tr> <tr> <td>VM1464A1</td> <td>CT BT TEMPERATUR E PROBE COVER</td> <td>1.000</td> <td>PC</td> </tr> <tr> <td>VM1465A1</td> <td>CT BT TEMPERATUR E PROBE COVER</td> <td>1.000</td> <td>PC</td> </tr> </tbody> </table>	Code	Description	Qty	UOM	TR1106B0	PT100 L=2000 TEMPERATUR E PROBE	1.000	PC	VI1220A1	4,2x12 TCB SELF-TAPPIN G SCREW	2.000	PC	VM1464A1	CT BT TEMPERATUR E PROBE COVER	1.000	PC	VM1465A1	CT BT TEMPERATUR E PROBE COVER	1.000	PC	
			Code	Description	Qty	UOM																				
			TR1106B0	PT100 L=2000 TEMPERATUR E PROBE	1.000	PC																				
VI1220A1	4,2x12 TCB SELF-TAPPIN G SCREW	2.000	PC																							
VM1464A1	CT BT TEMPERATUR E PROBE COVER	1.000	PC																							
VM1465A1	CT BT TEMPERATUR E PROBE COVER	1.000	PC																							
KTR1106A	5-5E S. L2000 CHAMBER TEMP. PROBE KIT	<table border="1"> <thead> <tr> <th>Code</th> <th>Description</th> <th>Qty</th> <th>UOM</th> </tr> </thead> <tbody> <tr> <td>GN1285A0</td> <td>NTC TEMPERATUR E PROBE SEALING</td> <td>1.000</td> <td>PC</td> </tr> <tr> <td>SL1045A0</td> <td>S57 BLACK SILICONE - 80ml CARTRIDGE</td> <td>1.000</td> <td>PC</td> </tr> <tr> <td>TR1106A3</td> <td>PT100 L=2000 TEMPERATUR E PROBE</td> <td>1.000</td> <td>PC</td> </tr> <tr> <td>VI1220A1</td> <td>4,2x12 TCB SELF-TAPPIN G SCREW</td> <td>2.000</td> <td>PC</td> </tr> <tr> <td>VM1465A1</td> <td>CT BT TEMPERATUR E PROBE COVER</td> <td>1.000</td> <td>PC</td> </tr> </tbody> </table>	Code	Description	Qty	UOM	GN1285A0	NTC TEMPERATUR E PROBE SEALING	1.000	PC	SL1045A0	S57 BLACK SILICONE - 80ml CARTRIDGE	1.000	PC	TR1106A3	PT100 L=2000 TEMPERATUR E PROBE	1.000	PC	VI1220A1	4,2x12 TCB SELF-TAPPIN G SCREW	2.000	PC	VM1465A1	CT BT TEMPERATUR E PROBE COVER	1.000	PC
Code	Description	Qty	UOM																							
GN1285A0	NTC TEMPERATUR E PROBE SEALING	1.000	PC																							
SL1045A0	S57 BLACK SILICONE - 80ml CARTRIDGE	1.000	PC																							
TR1106A3	PT100 L=2000 TEMPERATUR E PROBE	1.000	PC																							
VI1220A1	4,2x12 TCB SELF-TAPPIN G SCREW	2.000	PC																							
VM1465A1	CT BT TEMPERATUR E PROBE COVER	1.000	PC																							
KTR1105A	PT100 L1000 TEMPERATURE PROBE KIT	<table border="1"> <thead> <tr> <th>Code</th> <th>Description</th> <th>Qty</th> <th>UOM</th> </tr> </thead> <tbody> <tr> <td>GN1120A1</td> <td>NTC TEMPERATUR E PROBE SEAL</td> <td>1.000</td> <td>PC</td> </tr> <tr> <td>GN1285A0</td> <td>NTC TEMPERATUR E PROBE SEALING</td> <td>1.000</td> <td>PC</td> </tr> <tr> <td>SL1045A0</td> <td>S57 BLACK SILICONE - 80ml CARTRIDGE</td> <td>1.000</td> <td>PC</td> </tr> <tr> <td>TR1105A4</td> <td>L1000 PT100 TEMPERATUR E PROBE</td> <td>1.000</td> <td>PC</td> </tr> <tr> <td>VI1220A1</td> <td>4,2x12 TCB SELF-TAPPIN G SCREW</td> <td>2.000</td> <td>PC</td> </tr> </tbody> </table>	Code	Description	Qty	UOM	GN1120A1	NTC TEMPERATUR E PROBE SEAL	1.000	PC	GN1285A0	NTC TEMPERATUR E PROBE SEALING	1.000	PC	SL1045A0	S57 BLACK SILICONE - 80ml CARTRIDGE	1.000	PC	TR1105A4	L1000 PT100 TEMPERATUR E PROBE	1.000	PC	VI1220A1	4,2x12 TCB SELF-TAPPIN G SCREW	2.000	PC
Code	Description	Qty	UOM																							
GN1120A1	NTC TEMPERATUR E PROBE SEAL	1.000	PC																							
GN1285A0	NTC TEMPERATUR E PROBE SEALING	1.000	PC																							
SL1045A0	S57 BLACK SILICONE - 80ml CARTRIDGE	1.000	PC																							
TR1105A4	L1000 PT100 TEMPERATUR E PROBE	1.000	PC																							
VI1220A1	4,2x12 TCB SELF-TAPPIN G SCREW	2.000	PC																							



COMPONENT			SPARE PART																											
Code	Description	Image	Code	Description	Kit components																									
VM1465A	CT BT TEMPERATURE PROBE COVER		KTR1105A	PT100 L1000 TEMPERATURE PROBE KIT	<table border="1"> <thead> <tr> <th>Code</th> <th>Description</th> <th>Qty</th> <th>UOM</th> </tr> </thead> <tbody> <tr> <td>VM1464A1</td> <td>CT BT TEMPERATUR E PROBE COVER</td> <td>1.000</td> <td>PC</td> </tr> <tr> <td>VM1465A1</td> <td>CT BT TEMPERATUR E PROBE COVER</td> <td>1.000</td> <td>PC</td> </tr> <tr> <td>VM2052A0</td> <td>LM CORE PROBE COVE</td> <td>1.000</td> <td>PC</td> </tr> </tbody> </table>	Code	Description	Qty	UOM	VM1464A1	CT BT TEMPERATUR E PROBE COVER	1.000	PC	VM1465A1	CT BT TEMPERATUR E PROBE COVER	1.000	PC	VM2052A0	LM CORE PROBE COVE	1.000	PC									
			Code	Description	Qty	UOM																								
			VM1464A1	CT BT TEMPERATUR E PROBE COVER	1.000	PC																								
VM1465A1	CT BT TEMPERATUR E PROBE COVER	1.000	PC																											
VM2052A0	LM CORE PROBE COVE	1.000	PC																											
KTR1096A	NTC 150 L=1500 TEMPERATURE PROBE KIT	<table border="1"> <thead> <tr> <th>Code</th> <th>Description</th> <th>Qty</th> <th>UOM</th> </tr> </thead> <tbody> <tr> <td>GN1120A1</td> <td>NTC TEMPERATUR E PROBE SEAL</td> <td>1.000</td> <td>PC</td> </tr> <tr> <td>GN1285A0</td> <td>NTC TEMPERATUR E PROBE SEALING</td> <td>2.000</td> <td>PC</td> </tr> <tr> <td>SL1045A0</td> <td>S57 BLACK SILICONE - 80ml CARTRIDGE</td> <td>1.000</td> <td>PC</td> </tr> <tr> <td>TR1096A0</td> <td>TEMPERATUR E PROBE NTC 150 L=1500</td> <td>1.000</td> <td>PC</td> </tr> <tr> <td>VI1220A1</td> <td>4,2x12 TCB SELF-TAPPIN G SCREW</td> <td>2.000</td> <td>PC</td> </tr> <tr> <td>VM1465A1</td> <td>CT BT TEMPERATUR E PROBE COVER</td> <td>1.000</td> <td>PC</td> </tr> </tbody> </table>	Code	Description	Qty	UOM	GN1120A1	NTC TEMPERATUR E PROBE SEAL	1.000	PC	GN1285A0	NTC TEMPERATUR E PROBE SEALING	2.000	PC	SL1045A0	S57 BLACK SILICONE - 80ml CARTRIDGE	1.000	PC	TR1096A0	TEMPERATUR E PROBE NTC 150 L=1500	1.000	PC	VI1220A1	4,2x12 TCB SELF-TAPPIN G SCREW	2.000	PC	VM1465A1	CT BT TEMPERATUR E PROBE COVER	1.000	PC
Code	Description	Qty	UOM																											
GN1120A1	NTC TEMPERATUR E PROBE SEAL	1.000	PC																											
GN1285A0	NTC TEMPERATUR E PROBE SEALING	2.000	PC																											
SL1045A0	S57 BLACK SILICONE - 80ml CARTRIDGE	1.000	PC																											
TR1096A0	TEMPERATUR E PROBE NTC 150 L=1500	1.000	PC																											
VI1220A1	4,2x12 TCB SELF-TAPPIN G SCREW	2.000	PC																											
VM1465A1	CT BT TEMPERATUR E PROBE COVER	1.000	PC																											
KTR1095A	NTC 150 L=1050 TEMPERATURE PROBE KIT	<table border="1"> <thead> <tr> <th>Code</th> <th>Description</th> <th>Qty</th> <th>UOM</th> </tr> </thead> <tbody> <tr> <td>GN1120A1</td> <td>NTC TEMPERATUR E PROBE SEAL</td> <td>1.000</td> <td>PC</td> </tr> <tr> <td>GN1285A0</td> <td>NTC TEMPERATUR E PROBE SEALING</td> <td>1.000</td> <td>PC</td> </tr> <tr> <td>SL1045A0</td> <td>S57 BLACK SILICONE - 80ml CARTRIDGE</td> <td>1.000</td> <td>PC</td> </tr> <tr> <td>TR1095A0</td> <td>TEMPERATUR E PROBE NTC 150 L=1050</td> <td>1.000</td> <td>PC</td> </tr> <tr> <td>VI1220A1</td> <td>4,2x12 TCB SELF-TAPPIN G SCREW</td> <td>2.000</td> <td>PC</td> </tr> <tr> <td>VM1465A1</td> <td>CT BT TEMPERATUR E PROBE COVER</td> <td>1.000</td> <td>PC</td> </tr> </tbody> </table>	Code	Description	Qty	UOM	GN1120A1	NTC TEMPERATUR E PROBE SEAL	1.000	PC	GN1285A0	NTC TEMPERATUR E PROBE SEALING	1.000	PC	SL1045A0	S57 BLACK SILICONE - 80ml CARTRIDGE	1.000	PC	TR1095A0	TEMPERATUR E PROBE NTC 150 L=1050	1.000	PC	VI1220A1	4,2x12 TCB SELF-TAPPIN G SCREW	2.000	PC	VM1465A1	CT BT TEMPERATUR E PROBE COVER	1.000	PC
Code	Description	Qty	UOM																											
GN1120A1	NTC TEMPERATUR E PROBE SEAL	1.000	PC																											
GN1285A0	NTC TEMPERATUR E PROBE SEALING	1.000	PC																											
SL1045A0	S57 BLACK SILICONE - 80ml CARTRIDGE	1.000	PC																											
TR1095A0	TEMPERATUR E PROBE NTC 150 L=1050	1.000	PC																											
VI1220A1	4,2x12 TCB SELF-TAPPIN G SCREW	2.000	PC																											
VM1465A1	CT BT TEMPERATUR E PROBE COVER	1.000	PC																											



COMPONENT			SPARE PART																														
Code	Description	Image	Code	Description	Kit components																												
VM1465A	CT BT TEMPERATURE PROBE COVER		KTR1003B	US MM L2000 CHAMBER TEMP. PROBE KIT	<table border="1"> <thead> <tr> <th>Code</th> <th>Description</th> <th>Qty</th> <th>UOM</th> </tr> </thead> <tbody> <tr> <td>GN1285A0</td> <td>NTC TEMPERATUR E PROBE SEALING</td> <td>1.000</td> <td>PC</td> </tr> <tr> <td>SL1045A0</td> <td>S57 BLACK SILICONE - 80ml CARTRIDGE</td> <td>1.000</td> <td>PC</td> </tr> <tr> <td>TR1003B0</td> <td></td> <td>1.000</td> <td>PC</td> </tr> <tr> <td>VI1220A1</td> <td>4,2x12 TCB SELF-TAPPIN G SCREW</td> <td>2.000</td> <td>PC</td> </tr> <tr> <td>VM1464A1</td> <td>CT BT TEMPERATUR E PROBE COVER</td> <td>1.000</td> <td>PC</td> </tr> <tr> <td>VM1465A1</td> <td>CT BT TEMPERATUR E PROBE COVER</td> <td>1.000</td> <td>PC</td> </tr> </tbody> </table>	Code	Description	Qty	UOM	GN1285A0	NTC TEMPERATUR E PROBE SEALING	1.000	PC	SL1045A0	S57 BLACK SILICONE - 80ml CARTRIDGE	1.000	PC	TR1003B0		1.000	PC	VI1220A1	4,2x12 TCB SELF-TAPPIN G SCREW	2.000	PC	VM1464A1	CT BT TEMPERATUR E PROBE COVER	1.000	PC	VM1465A1	CT BT TEMPERATUR E PROBE COVER	1.000	PC
			Code	Description	Qty	UOM																											
			GN1285A0	NTC TEMPERATUR E PROBE SEALING	1.000	PC																											
SL1045A0	S57 BLACK SILICONE - 80ml CARTRIDGE	1.000	PC																														
TR1003B0		1.000	PC																														
VI1220A1	4,2x12 TCB SELF-TAPPIN G SCREW	2.000	PC																														
VM1464A1	CT BT TEMPERATUR E PROBE COVER	1.000	PC																														
VM1465A1	CT BT TEMPERATUR E PROBE COVER	1.000	PC																														
KTR1003A	5-5E S.CHEFTOP US TEMPERATURE PROBE KIT	<table border="1"> <thead> <tr> <th>Code</th> <th>Description</th> <th>Qty</th> <th>UOM</th> </tr> </thead> <tbody> <tr> <td>GN1285A0</td> <td>NTC TEMPERATUR E PROBE SEALING</td> <td>1.000</td> <td>PC</td> </tr> <tr> <td>SL1045A0</td> <td>S57 BLACK SILICONE - 80ml CARTRIDGE</td> <td>1.000</td> <td>PC</td> </tr> <tr> <td>TR1003A0</td> <td>PT100 L2000 TEMPERATUR E PROBE-US VERSION</td> <td>1.000</td> <td>PC</td> </tr> <tr> <td>VI1220A1</td> <td>4,2x12 TCB SELF-TAPPIN G SCREW</td> <td>2.000</td> <td>PC</td> </tr> <tr> <td>VM1465A1</td> <td>CT BT TEMPERATUR E PROBE COVER</td> <td>1.000</td> <td>PC</td> </tr> </tbody> </table>	Code	Description	Qty	UOM	GN1285A0	NTC TEMPERATUR E PROBE SEALING	1.000	PC	SL1045A0	S57 BLACK SILICONE - 80ml CARTRIDGE	1.000	PC	TR1003A0	PT100 L2000 TEMPERATUR E PROBE-US VERSION	1.000	PC	VI1220A1	4,2x12 TCB SELF-TAPPIN G SCREW	2.000	PC	VM1465A1	CT BT TEMPERATUR E PROBE COVER	1.000	PC							
Code	Description	Qty	UOM																														
GN1285A0	NTC TEMPERATUR E PROBE SEALING	1.000	PC																														
SL1045A0	S57 BLACK SILICONE - 80ml CARTRIDGE	1.000	PC																														
TR1003A0	PT100 L2000 TEMPERATUR E PROBE-US VERSION	1.000	PC																														
VI1220A1	4,2x12 TCB SELF-TAPPIN G SCREW	2.000	PC																														
VM1465A1	CT BT TEMPERATUR E PROBE COVER	1.000	PC																														
KTR1002A	PT100 L1000 UL TEMPERATURE PROBE KIT	<table border="1"> <thead> <tr> <th>Code</th> <th>Description</th> <th>Qty</th> <th>UOM</th> </tr> </thead> <tbody> <tr> <td>GN1285A0</td> <td>NTC TEMPERATUR E PROBE SEALING</td> <td>2.000</td> <td>PC</td> </tr> <tr> <td>SL1045A0</td> <td>S57 BLACK SILICONE - 80ml CARTRIDGE</td> <td>1.000</td> <td>PC</td> </tr> <tr> <td>TR1002A1</td> <td></td> <td>1.000</td> <td>PC</td> </tr> <tr> <td>VI1220A1</td> <td>4,2x12 TCB SELF-TAPPIN G SCREW</td> <td>2.000</td> <td>PC</td> </tr> <tr> <td>VM1465A1</td> <td>CT BT TEMPERATUR E PROBE COVER</td> <td>1.000</td> <td>PC</td> </tr> </tbody> </table>	Code	Description	Qty	UOM	GN1285A0	NTC TEMPERATUR E PROBE SEALING	2.000	PC	SL1045A0	S57 BLACK SILICONE - 80ml CARTRIDGE	1.000	PC	TR1002A1		1.000	PC	VI1220A1	4,2x12 TCB SELF-TAPPIN G SCREW	2.000	PC	VM1465A1	CT BT TEMPERATUR E PROBE COVER	1.000	PC							
Code	Description	Qty	UOM																														
GN1285A0	NTC TEMPERATUR E PROBE SEALING	2.000	PC																														
SL1045A0	S57 BLACK SILICONE - 80ml CARTRIDGE	1.000	PC																														
TR1002A1		1.000	PC																														
VI1220A1	4,2x12 TCB SELF-TAPPIN G SCREW	2.000	PC																														
VM1465A1	CT BT TEMPERATUR E PROBE COVER	1.000	PC																														

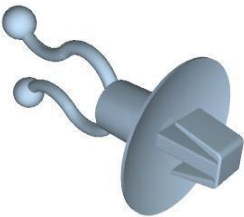

COMPONENT			SPARE PART		
Code	Description	Image	Code	Description	Kit components
VM1610A	CLIP TWIST LOCK DIAM. 7,6-10,2 MM		VM1605A0	CLIP TWIST LOCK DIAM. 10,2-12,7 MM	



PLATON SERVICE

8 (800) 500-34-47

www.platonservice.com



ASM2094A/0.D00 - External cover







ASM2094A/0.D00 - External cover

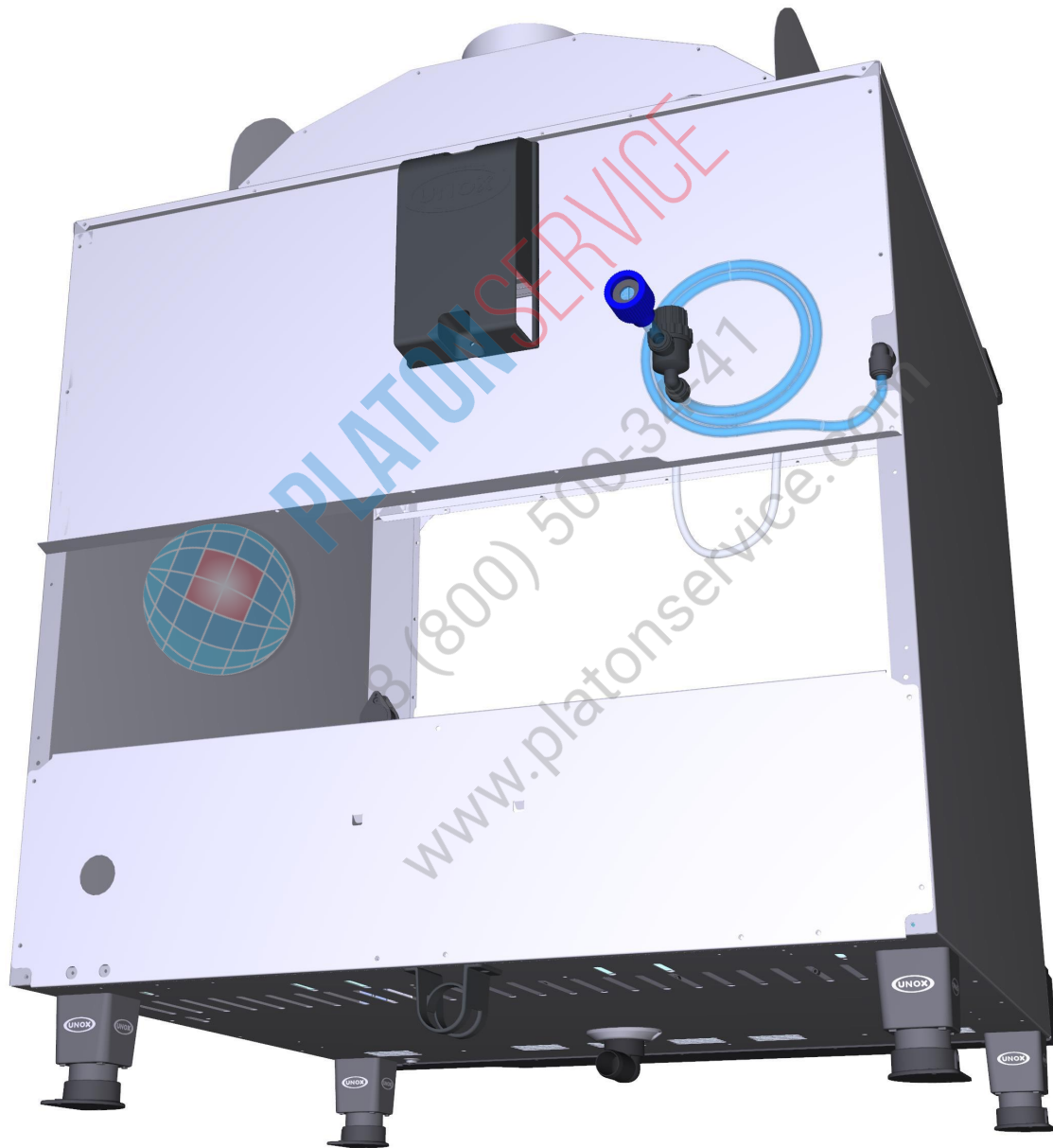



REAR

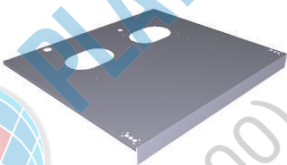
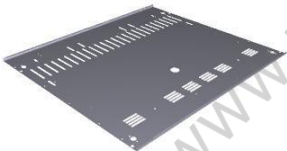
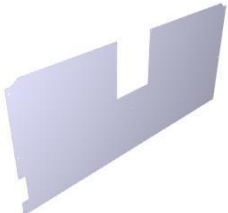



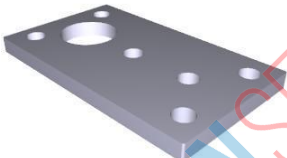

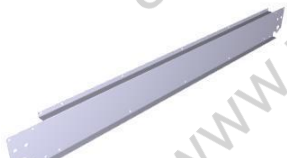
COMPONENT			SPARE PART		
Code	Description	Image	Code	Description	Kit components
0D2207A	CHEF-BAKERLUX EXTERNAL LEFT SIDE PANEL		0D2207A0	CHEF-BAKERLUX EXTERNAL LEFT SIDE PANEL	
0D2208A	CHEF-BAKERLUX EXTERNAL RIGHT SIDE PANEL		0D2208A0	CHEF-BAKERLUX EXTERNAL RIGHT SIDE PANEL	
0D2209B	CHEF-BAKERLUX GAS EXTERNAL UPPER COVER		0D2209B0	CHEF-BAKERLUX GAS EXTERNAL UPPER COVER	
0E1331B	CHEFLUX-BAKERLU X EXTERNAL BOTTOM PANEL		0E1331B0	CHEFLUX-BAKERLU X EXTERNAL BOTTOM PANEL	
0F1462A	XB613G-XV513G BACK PANEL		0F1462A0	XB613G-XV513G BACK PANEL	





COMPONENT			SPARE PART		
Code	Description	Image	Code	Description	Kit components
0H1450A	XB-XV-XG ST. STEEL MUFFLE FRONT CORNER		OUTOFPRODUCTIO	ITEM OUT OF PRODUCTION	
0H2560A	XBC/XVC ZINC PLAT. DOOR COUNTERBRACKET		0H2560A0	XBC/XVC ZINC PLAT. DOOR COUNTERBRACKET	
0H3790A	CHIMNEY HOLDING PLATE		0H3790A0	CHIMNEY HOLDING PLATE	
0H6240A	BAKERLUX CHEFLUX ST. STEEL CONTROL PANEL		0H6240A0	BAKERLUX CHEFLUX ST. STEEL CONTROL PANEL	
0H6333A	BL CL THREADED DOOR COUNTER BRACKET		0H6333A0	BL CL THREADED DOOR COUNTER BRACKET	

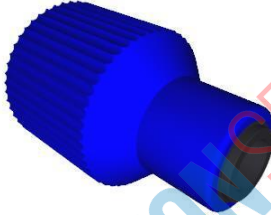
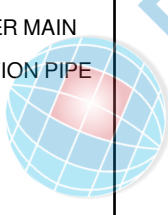

COMPONENT			SPARE PART										
Code	Description	Image	Code	Description	Kit components								
0H6569A	CHEF-BAKERLUX GAS EXTERNAL BACK COVER		0H6569A0	CHEF-BAKERLUX GAS EXTERNAL BACK COVER									
0N1379A	HEAT EXCHANGER LATERAL PANEL		0N1379A0	HEAT EXCHANGER LATERAL PANEL									
VE1295A	MK 16A 230V DOOR MICROSWITCH		KVE1295A	16A 230V DOOR MICROSWITCH KIT	<table border="1"> <thead> <tr> <th>Code</th> <th>Description</th> <th>Qty</th> <th>UOM</th> </tr> </thead> <tbody> <tr> <td>VE1295A0</td> <td>MK 16A 230V DOOR MICROSWITC</td> <td>1.000</td> <td>PC</td> </tr> </tbody> </table>	Code	Description	Qty	UOM	VE1295A0	MK 16A 230V DOOR MICROSWITC	1.000	PC
Code	Description	Qty	UOM										
VE1295A0	MK 16A 230V DOOR MICROSWITC	1.000	PC										
VM1200A	DOOR MECHANIC MICROSWITCH SUPPORT PLATE		VM1200A0	DOOR MECHANIC MICROSWITCH SUPPORT PLATE									
EL1349A	CLIP TO FIX Ø10 mm CONNECTION JOIN		KEL1349A	Ø10 FITTING LOCKING CLIPS 10 PCS KIT	<table border="1"> <thead> <tr> <th>Code</th> <th>Description</th> <th>Qty</th> <th>UOM</th> </tr> </thead> <tbody> <tr> <td>EL1349A0</td> <td>CLIP TO FIX Ø10 mm CONNECTION JOINT</td> <td>10.000</td> <td>PC</td> </tr> </tbody> </table>	Code	Description	Qty	UOM	EL1349A0	CLIP TO FIX Ø10 mm CONNECTION JOINT	10.000	PC
Code	Description	Qty	UOM										
EL1349A0	CLIP TO FIX Ø10 mm CONNECTION JOINT	10.000	PC										

COMPONENT			SPARE PART										
Code	Description	Image	Code	Description	Kit components								
RC1360A	10 - 10 JG ELBOW FITTING		KRC1360A	D10 - D10 JG ELBOW FITTING 10 PCS KIT	<table border="1"> <thead> <tr> <th>Code</th> <th>Description</th> <th>Qty</th> <th>UOM</th> </tr> </thead> <tbody> <tr> <td>RC1360A0</td> <td>10 - 10 JG ELBOW FITTING</td> <td>10.000</td> <td>PC</td> </tr> </tbody> </table>	Code	Description	Qty	UOM	RC1360A0	10 - 10 JG ELBOW FITTING	10.000	PC
					Code	Description	Qty	UOM					
RC1360A0	10 - 10 JG ELBOW FITTING	10.000	PC										
<table border="1"> <thead> <tr> <th>Code</th> <th>Description</th> <th>Qty</th> <th>UOM</th> </tr> </thead> <tbody> <tr> <td>VL1145A1</td> <td></td> <td>1.000</td> <td>PC</td> </tr> </tbody> </table>	Code	Description	Qty	UOM	VL1145A1		1.000	PC					
Code	Description	Qty	UOM										
VL1145A1		1.000	PC										
RC1365A	3/4"-10 JG FEMALE CONNECTION		KVL1145A	3/4-JG8 FITTING WITH FILTER AND NRV KIT	<table border="1"> <thead> <tr> <th>Code</th> <th>Description</th> <th>Qty</th> <th>UOM</th> </tr> </thead> <tbody> <tr> <td>VL1145A1</td> <td></td> <td>1.000</td> <td>PC</td> </tr> </tbody> </table>	Code	Description	Qty	UOM	VL1145A1		1.000	PC
					Code	Description	Qty	UOM					
VL1145A1		1.000	PC										
<table border="1"> <thead> <tr> <th>Code</th> <th>Description</th> <th>Qty</th> <th>UOM</th> </tr> </thead> <tbody> <tr> <td>RC1360A0</td> <td>10 - 10 JG ELBOW FITTING</td> <td>1.000</td> <td>PC</td> </tr> <tr> <td>VL1135A1</td> <td>3/4-JG10 CONNECTOR + FILTER AND NRV</td> <td>1.000</td> <td>PC</td> </tr> </tbody> </table>	Code	Description	Qty	UOM	RC1360A0	10 - 10 JG ELBOW FITTING	1.000	PC	VL1135A1	3/4-JG10 CONNECTOR + FILTER AND NRV	1.000	PC	
Code	Description	Qty	UOM										
RC1360A0	10 - 10 JG ELBOW FITTING	1.000	PC										
VL1135A1	3/4-JG10 CONNECTOR + FILTER AND NRV	1.000	PC										
TB2237A	Ø10 WATER MAIN CONNECTION PIPE		KTB2599A	Ø10 PET WATER PIPE TB2243A0 100M KIT	<table border="1"> <thead> <tr> <th>Code</th> <th>Description</th> <th>Qty</th> <th>UOM</th> </tr> </thead> <tbody> <tr> <td>TB2243A0</td> <td>D10 PE TRANSPARENT PIPE</td> <td>100.000</td> <td>M</td> </tr> </tbody> </table>	Code	Description	Qty	UOM	TB2243A0	D10 PE TRANSPARENT PIPE	100.000	M
					Code	Description	Qty	UOM					
TB2243A0	D10 PE TRANSPARENT PIPE	100.000	M										
<table border="1"> <thead> <tr> <th>Code</th> <th>Description</th> <th>Qty</th> <th>UOM</th> </tr> </thead> <tbody> <tr> <td>TB2243A0</td> <td>D10 PE TRANSPARENT PIPE</td> <td>3.000</td> <td>M</td> </tr> </tbody> </table>	Code	Description	Qty	UOM	TB2243A0	D10 PE TRANSPARENT PIPE	3.000	M					
Code	Description	Qty	UOM										
TB2243A0	D10 PE TRANSPARENT PIPE	3.000	M										
VL1034C	MESH WATER FILTER D10		KVL1135A	3/4-JG10 FITTING WITH FILTER AND VNR KIT	<table border="1"> <thead> <tr> <th>Code</th> <th>Description</th> <th>Qty</th> <th>UOM</th> </tr> </thead> <tbody> <tr> <td>RC1360A0</td> <td>10 - 10 JG ELBOW FITTING</td> <td>1.000</td> <td>PC</td> </tr> </tbody> </table>	Code	Description	Qty	UOM	RC1360A0	10 - 10 JG ELBOW FITTING	1.000	PC
					Code	Description	Qty	UOM					
RC1360A0	10 - 10 JG ELBOW FITTING	1.000	PC										
<table border="1"> <thead> <tr> <th>Code</th> <th>Description</th> <th>Qty</th> <th>UOM</th> </tr> </thead> <tbody> <tr> <td>VL1135A1</td> <td>3/4-JG10 CONNECTOR + FILTER AND NRV</td> <td>1.000</td> <td>PC</td> </tr> </tbody> </table>	Code	Description	Qty	UOM	VL1135A1	3/4-JG10 CONNECTOR + FILTER AND NRV	1.000	PC					
Code	Description	Qty	UOM										
VL1135A1	3/4-JG10 CONNECTOR + FILTER AND NRV	1.000	PC										
VL1026A	BEND FOR DRAIN PIPE		KVL1026A	DRAIN PIPE BEND KI	<table border="1"> <thead> <tr> <th>Code</th> <th>Description</th> <th>Qty</th> <th>UOM</th> </tr> </thead> <tbody> <tr> <td>GN1400A0</td> <td>U-TRAP SEAL</td> <td>1.000</td> <td>PC</td> </tr> </tbody> </table>	Code	Description	Qty	UOM	GN1400A0	U-TRAP SEAL	1.000	PC
					Code	Description	Qty	UOM					
					GN1400A0	U-TRAP SEAL	1.000	PC					
<table border="1"> <thead> <tr> <th>Code</th> <th>Description</th> <th>Qty</th> <th>UOM</th> </tr> </thead> <tbody> <tr> <td>VL1026A0</td> <td>BEND FOR DRAIN PIPE</td> <td>1.000</td> <td>PC</td> </tr> </tbody> </table>	Code	Description	Qty	UOM	VL1026A0	BEND FOR DRAIN PIPE	1.000	PC					
Code	Description	Qty	UOM										
VL1026A0	BEND FOR DRAIN PIPE	1.000	PC										
<table border="1"> <thead> <tr> <th>Code</th> <th>Description</th> <th>Qty</th> <th>UOM</th> </tr> </thead> <tbody> <tr> <td>VM2039A0</td> <td>DRAIN BEND FIXING RING</td> <td>1.000</td> <td>PC</td> </tr> </tbody> </table>	Code	Description	Qty	UOM	VM2039A0	DRAIN BEND FIXING RING	1.000	PC					
Code	Description	Qty	UOM										
VM2039A0	DRAIN BEND FIXING RING	1.000	PC										

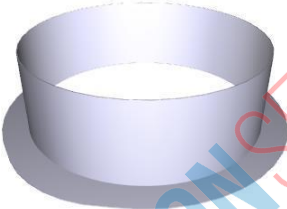

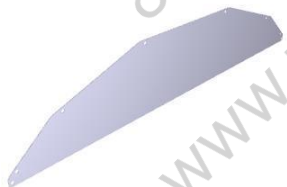
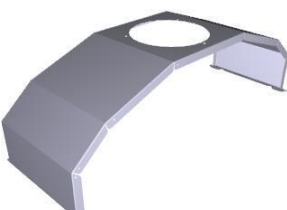

COMPONENT			SPARE PART																						
Code	Description	Image	Code	Description	Kit components																				
VM2039A	DRAIN BEND FIXING RING		KVL1026A	DRAIN PIPE BEND KI	<table border="1"> <thead> <tr> <th>Code</th> <th>Description</th> <th>Qty</th> <th>UOM</th> </tr> </thead> <tbody> <tr> <td>GN1400A0</td> <td>U-TRAP SEAL</td> <td>1.000</td> <td>PC</td> </tr> <tr> <td>VL1026A0</td> <td>BEND FOR DRAIN PIPE</td> <td>1.000</td> <td>PC</td> </tr> <tr> <td>VM2039A0</td> <td>DRAIN BEND FIXING RING</td> <td>1.000</td> <td>PC</td> </tr> </tbody> </table>	Code	Description	Qty	UOM	GN1400A0	U-TRAP SEAL	1.000	PC	VL1026A0	BEND FOR DRAIN PIPE	1.000	PC	VM2039A0	DRAIN BEND FIXING RING	1.000	PC				
					Code	Description	Qty	UOM																	
GN1400A0	U-TRAP SEAL	1.000	PC																						
VL1026A0	BEND FOR DRAIN PIPE	1.000	PC																						
VM2039A0	DRAIN BEND FIXING RING	1.000	PC																						
ON1047A	XG DRAFT SWITCH ENTRANCE RING		ON1047A0	XG DRAFT SWITCH ENTRANCE RING																					
ON1210A	XVC GAS DRAFT STOPPER EXTERNAL COVER		ON1210A3	XVC GAS DRAFT STOPPER EXTERNAL COVER																					
ON1356A	XVC FUMES SWITCH SIDE PLATE		ON1356A0	XVC FUMES SWITCH SIDE PLATE																					
ON1371B	CHEF-BAKERLUX GAS FUMES DRAFT SWITCH		KON1371B	LUX FUMES DRAFT SWITCH KIT	<table border="1"> <thead> <tr> <th>Code</th> <th>Description</th> <th>Qty</th> <th>UOM</th> </tr> </thead> <tbody> <tr> <td>ON1047A0</td> <td>XG DRAFT SWITCH ENTRANCE RING</td> <td>1.000</td> <td>PC</td> </tr> <tr> <td>ON1356A0</td> <td>XVC FUMES SWITCH SIDE PLATE</td> <td>2.000</td> <td>PC</td> </tr> <tr> <td>ON1371B0</td> <td>CHEF-BAKERLUX GAS FUMES DRAFT SWITCH</td> <td>1.000</td> <td>PC</td> </tr> <tr> <td>VI1220A1</td> <td>4,2x12 TCB SELF-TAPPING SCREW</td> <td>22.000</td> <td>PC</td> </tr> </tbody> </table>	Code	Description	Qty	UOM	ON1047A0	XG DRAFT SWITCH ENTRANCE RING	1.000	PC	ON1356A0	XVC FUMES SWITCH SIDE PLATE	2.000	PC	ON1371B0	CHEF-BAKERLUX GAS FUMES DRAFT SWITCH	1.000	PC	VI1220A1	4,2x12 TCB SELF-TAPPING SCREW	22.000	PC
					Code	Description	Qty	UOM																	
					ON1047A0	XG DRAFT SWITCH ENTRANCE RING	1.000	PC																	
					ON1356A0	XVC FUMES SWITCH SIDE PLATE	2.000	PC																	
ON1371B0	CHEF-BAKERLUX GAS FUMES DRAFT SWITCH	1.000	PC																						
VI1220A1	4,2x12 TCB SELF-TAPPING SCREW	22.000	PC																						



COMPONENT			SPARE PART																		
Code	Description	Image	Code	Description	Kit components																
PD1063A	CT BT FOOT STOP BRACKET		KPD1063A	OVEN FOOT STOPPING BRACKET KIT	<table border="1"> <thead> <tr> <th>Code</th> <th>Description</th> <th>Qty</th> <th>UOM</th> </tr> </thead> <tbody> <tr> <td>PD1063A0</td> <td>CT BT FOOT STOP BRACKET</td> <td>4.000</td> <td>PC</td> </tr> <tr> <td>VI1950A0</td> <td>ST. STEEL 4,2X13 TCB SELF-DRILLIN G SCREW</td> <td>8.000</td> <td>PC</td> </tr> </tbody> </table>	Code	Description	Qty	UOM	PD1063A0	CT BT FOOT STOP BRACKET	4.000	PC	VI1950A0	ST. STEEL 4,2X13 TCB SELF-DRILLIN G SCREW	8.000	PC				
					Code	Description	Qty	UOM													
PD1063A0	CT BT FOOT STOP BRACKET	4.000	PC																		
VI1950A0	ST. STEEL 4,2X13 TCB SELF-DRILLIN G SCREW	8.000	PC																		
<table border="1"> <thead> <tr> <th>Code</th> <th>Description</th> <th>Qty</th> <th>UOM</th> </tr> </thead> <tbody> <tr> <td>PD1063A0</td> <td>CT BT FOOT STOP BRACKET</td> <td>1.000</td> <td>PC</td> </tr> <tr> <td>PD1066B0</td> <td>BI-COMPONE NT FOOT H100 (E SERIES FOOT)</td> <td>1.000</td> <td>PC</td> </tr> <tr> <td>VI1220A1</td> <td>4,2x12 TCB SELF-TAPPIN G SCREW</td> <td>5.000</td> <td>PC</td> </tr> </tbody> </table>	Code	Description	Qty	UOM	PD1063A0	CT BT FOOT STOP BRACKET	1.000	PC	PD1066B0	BI-COMPONE NT FOOT H100 (E SERIES FOOT)	1.000	PC	VI1220A1	4,2x12 TCB SELF-TAPPIN G SCREW	5.000	PC					
Code	Description	Qty	UOM																		
PD1063A0	CT BT FOOT STOP BRACKET	1.000	PC																		
PD1066B0	BI-COMPONE NT FOOT H100 (E SERIES FOOT)	1.000	PC																		
VI1220A1	4,2x12 TCB SELF-TAPPIN G SCREW	5.000	PC																		
PD1066B	BI-COMPONENT FOOT H100 (E SERIES FOOT)		KPD1066B	E SERIES OVEN H100 FOOT KIT	<table border="1"> <thead> <tr> <th>Code</th> <th>Description</th> <th>Qty</th> <th>UOM</th> </tr> </thead> <tbody> <tr> <td>PD1063A0</td> <td>CT BT FOOT STOP BRACKET</td> <td>1.000</td> <td>PC</td> </tr> <tr> <td>PD1066B0</td> <td>BI-COMPONE NT FOOT H100 (E SERIES FOOT)</td> <td>1.000</td> <td>PC</td> </tr> <tr> <td>VI1220A1</td> <td>4,2x12 TCB SELF-TAPPIN G SCREW</td> <td>5.000</td> <td>PC</td> </tr> </tbody> </table>	Code	Description	Qty	UOM	PD1063A0	CT BT FOOT STOP BRACKET	1.000	PC	PD1066B0	BI-COMPONE NT FOOT H100 (E SERIES FOOT)	1.000	PC	VI1220A1	4,2x12 TCB SELF-TAPPIN G SCREW	5.000	PC
					Code	Description	Qty	UOM													
PD1063A0	CT BT FOOT STOP BRACKET	1.000	PC																		
PD1066B0	BI-COMPONE NT FOOT H100 (E SERIES FOOT)	1.000	PC																		
VI1220A1	4,2x12 TCB SELF-TAPPIN G SCREW	5.000	PC																		
<table border="1"> <thead> <tr> <th>Code</th> <th>Description</th> <th>Qty</th> <th>UOM</th> </tr> </thead> <tbody> <tr> <td>VI1099A0</td> <td>SELF-DRILLIN G SCREW 4.8X13 TCB+ Z</td> <td>4.000</td> <td>PC</td> </tr> <tr> <td>VM1555A2</td> <td>CT BT COOLING FAN SUPPORT</td> <td>1.000</td> <td>PC</td> </tr> <tr> <td>VN1165A0</td> <td>230Vac 50/60Hz COOLING DOWN FAN</td> <td>1.000</td> <td>PC</td> </tr> </tbody> </table>	Code	Description	Qty	UOM	VI1099A0	SELF-DRILLIN G SCREW 4.8X13 TCB+ Z	4.000	PC	VM1555A2	CT BT COOLING FAN SUPPORT	1.000	PC	VN1165A0	230Vac 50/60Hz COOLING DOWN FAN	1.000	PC					
Code	Description	Qty	UOM																		
VI1099A0	SELF-DRILLIN G SCREW 4.8X13 TCB+ Z	4.000	PC																		
VM1555A2	CT BT COOLING FAN SUPPORT	1.000	PC																		
VN1165A0	230Vac 50/60Hz COOLING DOWN FAN	1.000	PC																		
VM1555A	CT BT COOLING FAN SUPPORT		KVN1165A	S.5E ADVANCE/MM 230V COOLING FAN KIT	<table border="1"> <thead> <tr> <th>Code</th> <th>Description</th> <th>Qty</th> <th>UOM</th> </tr> </thead> <tbody> <tr> <td>VI1099A0</td> <td>SELF-DRILLIN G SCREW 4.8X13 TCB+ Z</td> <td>4.000</td> <td>PC</td> </tr> <tr> <td>VM1555A2</td> <td>CT BT COOLING FAN SUPPORT</td> <td>1.000</td> <td>PC</td> </tr> <tr> <td>VN1165A0</td> <td>230Vac 50/60Hz COOLING DOWN FAN</td> <td>1.000</td> <td>PC</td> </tr> </tbody> </table>	Code	Description	Qty	UOM	VI1099A0	SELF-DRILLIN G SCREW 4.8X13 TCB+ Z	4.000	PC	VM1555A2	CT BT COOLING FAN SUPPORT	1.000	PC	VN1165A0	230Vac 50/60Hz COOLING DOWN FAN	1.000	PC
					Code	Description	Qty	UOM													
VI1099A0	SELF-DRILLIN G SCREW 4.8X13 TCB+ Z	4.000	PC																		
VM1555A2	CT BT COOLING FAN SUPPORT	1.000	PC																		
VN1165A0	230Vac 50/60Hz COOLING DOWN FAN	1.000	PC																		
<table border="1"> <thead> <tr> <th>Code</th> <th>Description</th> <th>Qty</th> <th>UOM</th> </tr> </thead> <tbody> <tr> <td>VI1099A0</td> <td>SELF-DRILLIN G SCREW 4.8X13 TCB+ Z</td> <td>4.000</td> <td>PC</td> </tr> <tr> <td>VM1555A2</td> <td>CT BT COOLING FAN SUPPORT</td> <td>1.000</td> <td>PC</td> </tr> <tr> <td>VN1164A0</td> <td>12VDC COOLING DONW FAN</td> <td>1.000</td> <td>PC</td> </tr> </tbody> </table>	Code	Description	Qty	UOM	VI1099A0	SELF-DRILLIN G SCREW 4.8X13 TCB+ Z	4.000	PC	VM1555A2	CT BT COOLING FAN SUPPORT	1.000	PC	VN1164A0	12VDC COOLING DONW FAN	1.000	PC					
Code	Description	Qty	UOM																		
VI1099A0	SELF-DRILLIN G SCREW 4.8X13 TCB+ Z	4.000	PC																		
VM1555A2	CT BT COOLING FAN SUPPORT	1.000	PC																		
VN1164A0	12VDC COOLING DONW FAN	1.000	PC																		
VM1556A	XBC-XVC COOLING FAN GUARD		KVM1556A	XBC-XVC COOLING FAN GUARD KIT	<table border="1"> <thead> <tr> <th>Code</th> <th>Description</th> <th>Qty</th> <th>UOM</th> </tr> </thead> <tbody> <tr> <td>VM1556A0</td> <td>XBC-XVC COOLING FAN GUARD</td> <td>1.000</td> <td>PC</td> </tr> </tbody> </table>	Code	Description	Qty	UOM	VM1556A0	XBC-XVC COOLING FAN GUARD	1.000	PC								
					Code	Description	Qty	UOM													
VM1556A0	XBC-XVC COOLING FAN GUARD	1.000	PC																		
<table border="1"> <thead> <tr> <th>Code</th> <th>Description</th> <th>Qty</th> <th>UOM</th> </tr> </thead> <tbody> <tr> <td>VM1556A0</td> <td>XBC-XVC COOLING FAN GUARD</td> <td>1.000</td> <td>PC</td> </tr> </tbody> </table>	Code	Description	Qty	UOM	VM1556A0	XBC-XVC COOLING FAN GUARD	1.000	PC													
Code	Description	Qty	UOM																		
VM1556A0	XBC-XVC COOLING FAN GUARD	1.000	PC																		

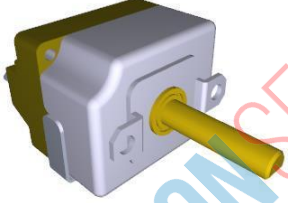
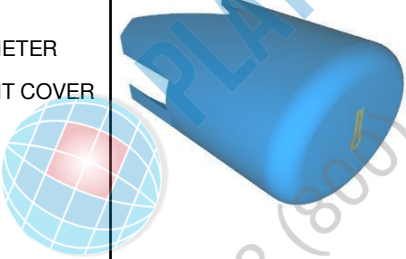

COMPONENT			SPARE PART																						
Code	Description	Image	Code	Description	Kit components																				
VN1165A	230Vac 50/60Hz COOLING DOWN FA		KVN1165A	S.5E ADVANCE/MM 230V COOLING FAN KIT	<table border="1"> <thead> <tr> <th>Code</th> <th>Description</th> <th>Qty</th> <th>UOM</th> </tr> </thead> <tbody> <tr> <td>VI1099A0</td> <td>SELF-DRILLIN G SCREW 4.8X13 TCB+ Z</td> <td>4.000</td> <td>PC</td> </tr> <tr> <td>VM1555A2</td> <td>CT BT COOLING FAN SUPPORT</td> <td>1.000</td> <td>PC</td> </tr> <tr> <td>VN1165A0</td> <td>230Vac 50/60Hz COOLING DOWN FAN</td> <td>1.000</td> <td>PC</td> </tr> </tbody> </table>	Code	Description	Qty	UOM	VI1099A0	SELF-DRILLIN G SCREW 4.8X13 TCB+ Z	4.000	PC	VM1555A2	CT BT COOLING FAN SUPPORT	1.000	PC	VN1165A0	230Vac 50/60Hz COOLING DOWN FAN	1.000	PC				
					Code	Description	Qty	UOM																	
VI1099A0	SELF-DRILLIN G SCREW 4.8X13 TCB+ Z	4.000	PC																						
VM1555A2	CT BT COOLING FAN SUPPORT	1.000	PC																						
VN1165A0	230Vac 50/60Hz COOLING DOWN FAN	1.000	PC																						
MN1111A	CHEFLUX BAKERLUX THERMOSTAT KNO		KMN1111A	CL/BL THERMOSTAT KNOB (CELSIUS)	<table border="1"> <thead> <tr> <th>Code</th> <th>Description</th> <th>Qty</th> <th>UOM</th> </tr> </thead> <tbody> <tr> <td>MN1111A1</td> <td>CHEFLUX BAKERLUX THERMOSTAT KNOB</td> <td>1.000</td> <td>PC</td> </tr> </tbody> </table>	Code	Description	Qty	UOM	MN1111A1	CHEFLUX BAKERLUX THERMOSTAT KNOB	1.000	PC												
Code	Description	Qty	UOM																						
MN1111A1	CHEFLUX BAKERLUX THERMOSTAT KNOB	1.000	PC																						
MN1112A	CHEFLUX BAKERLUX TIMER KNOB		KMN1112A	CHEFLUX/BAKERLU X TIMER KNOB KIT	<table border="1"> <thead> <tr> <th>Code</th> <th>Description</th> <th>Qty</th> <th>UOM</th> </tr> </thead> <tbody> <tr> <td>MN1112A1</td> <td>CHEFLUX BAKERLUX TIMER KNOB</td> <td>1.000</td> <td>PC</td> </tr> </tbody> </table>	Code	Description	Qty	UOM	MN1112A1	CHEFLUX BAKERLUX TIMER KNOB	1.000	PC												
Code	Description	Qty	UOM																						
MN1112A1	CHEFLUX BAKERLUX TIMER KNOB	1.000	PC																						
MN1113A	CHEFLUX BAKERLUX HUMIDITY CONTROL KNOB		KMN1113A	CL/BL HUMIDITY CONTROL KNOB KIT	<table border="1"> <thead> <tr> <th>Code</th> <th>Description</th> <th>Qty</th> <th>UOM</th> </tr> </thead> <tbody> <tr> <td>MN1113A2</td> <td>CHEFLUX BAKERLUX HUMIDITY CONTROL KNOB</td> <td>1.000</td> <td>PC</td> </tr> </tbody> </table>	Code	Description	Qty	UOM	MN1113A2	CHEFLUX BAKERLUX HUMIDITY CONTROL KNOB	1.000	PC												
Code	Description	Qty	UOM																						
MN1113A2	CHEFLUX BAKERLUX HUMIDITY CONTROL KNOB	1.000	PC																						
TM1001C	15 SEC 120V ELECTRONIC BUZZE		KTM1001C	15 SEC BUZZER KIT	<table border="1"> <thead> <tr> <th>Code</th> <th>Description</th> <th>Qty</th> <th>UOM</th> </tr> </thead> <tbody> <tr> <td>TM1001C3</td> <td>15 SEC 120/240V BUZZER KIT</td> <td>1.000</td> <td>PC</td> </tr> <tr> <td>VI1220A1</td> <td>4,2x12 TCB SELF-TAPPIN G SCREW</td> <td>3.000</td> <td>PC</td> </tr> <tr> <td>VI1850A0</td> <td>TCB M4x6 SCREW</td> <td>3.000</td> <td>PC</td> </tr> <tr> <td>VM1745A0</td> <td>CARD SUPPORT</td> <td>3.000</td> <td>PC</td> </tr> </tbody> </table>	Code	Description	Qty	UOM	TM1001C3	15 SEC 120/240V BUZZER KIT	1.000	PC	VI1220A1	4,2x12 TCB SELF-TAPPIN G SCREW	3.000	PC	VI1850A0	TCB M4x6 SCREW	3.000	PC	VM1745A0	CARD SUPPORT	3.000	PC
					Code	Description	Qty	UOM																	
					TM1001C3	15 SEC 120/240V BUZZER KIT	1.000	PC																	
					VI1220A1	4,2x12 TCB SELF-TAPPIN G SCREW	3.000	PC																	
VI1850A0	TCB M4x6 SCREW	3.000	PC																						
VM1745A0	CARD SUPPORT	3.000	PC																						

COMPONENT			SPARE PART																										
Code	Description	Image	Code	Description	Kit components																								
TM1005A	MI2 60 MIN 250V 16A TIMER		KTM1005A	60 MIN TIMER KIT	<table border="1"> <thead> <tr> <th>Code</th> <th>Description</th> <th>Qty</th> <th>UOM</th> </tr> </thead> <tbody> <tr> <td>TM1005A0</td> <td>MI2 60 MIN 250V 16A TIME</td> <td>1.000</td> <td>PC</td> </tr> <tr> <td>VI1850A0</td> <td>TCB M4x6 SCREW</td> <td>2.000</td> <td>PC</td> </tr> </tbody> </table>	Code	Description	Qty	UOM	TM1005A0	MI2 60 MIN 250V 16A TIME	1.000	PC	VI1850A0	TCB M4x6 SCREW	2.000	PC												
					Code	Description	Qty	UOM																					
TM1005A0	MI2 60 MIN 250V 16A TIME	1.000	PC																										
VI1850A0	TCB M4x6 SCREW	2.000	PC																										
<table border="1"> <thead> <tr> <th>Code</th> <th>Description</th> <th>Qty</th> <th>UOM</th> </tr> </thead> <tbody> <tr> <td>TR1100A0</td> <td>269°C 55.19052.80 ADJUSTABLE THERMOSTAT</td> <td>1.000</td> <td>PC</td> </tr> <tr> <td>VI1850A0</td> <td>TCB M4x6 SCREW</td> <td>2.000</td> <td>PC</td> </tr> </tbody> </table>	Code	Description	Qty	UOM	TR1100A0	269°C 55.19052.80 ADJUSTABLE THERMOSTAT	1.000	PC	VI1850A0	TCB M4x6 SCREW	2.000	PC																	
Code	Description	Qty	UOM																										
TR1100A0	269°C 55.19052.80 ADJUSTABLE THERMOSTAT	1.000	PC																										
VI1850A0	TCB M4x6 SCREW	2.000	PC																										
TR1100A	269°C 55.19052.80 ADJUSTABLE THERMOSTAT		KTR1100A	269°C THERMOSTAT KIT	<table border="1"> <thead> <tr> <th>Code</th> <th>Description</th> <th>Qty</th> <th>UOM</th> </tr> </thead> <tbody> <tr> <td>TR1100A0</td> <td>269°C 55.19052.80 ADJUSTABLE THERMOSTAT</td> <td>1.000</td> <td>PC</td> </tr> <tr> <td>VI1850A0</td> <td>TCB M4x6 SCREW</td> <td>2.000</td> <td>PC</td> </tr> </tbody> </table>	Code	Description	Qty	UOM	TR1100A0	269°C 55.19052.80 ADJUSTABLE THERMOSTAT	1.000	PC	VI1850A0	TCB M4x6 SCREW	2.000	PC												
Code	Description	Qty	UOM																										
TR1100A0	269°C 55.19052.80 ADJUSTABLE THERMOSTAT	1.000	PC																										
VI1850A0	TCB M4x6 SCREW	2.000	PC																										
VE1530A	GOLD THERMOMETER BLUE LIGHT COVER		KLP1012A	GOLDEN THERMOMETER BLUE LIGHT KIT	<table border="1"> <thead> <tr> <th>Code</th> <th>Description</th> <th>Qty</th> <th>UOM</th> </tr> </thead> <tbody> <tr> <td>VE1170A0</td> <td>D16 OPAQUE NICKEL ELLIPTICAL SUPPORT</td> <td>1.000</td> <td>PC</td> </tr> <tr> <td>VE1530A0</td> <td>GOLD THERMOMETE R BLUE LIGHT COVER</td> <td>1.000</td> <td>PC</td> </tr> <tr> <td>VE1535A1</td> <td>230V WHITE LED</td> <td>1.000</td> <td>PC</td> </tr> <tr> <td>VM1762A0</td> <td>INNER LAMP SUPPORT</td> <td>1.000</td> <td>PC</td> </tr> <tr> <td>VM2009A0</td> <td>D16 SILVER ELLIPTICAL SUPPORT</td> <td>1.000</td> <td>PC</td> </tr> </tbody> </table>	Code	Description	Qty	UOM	VE1170A0	D16 OPAQUE NICKEL ELLIPTICAL SUPPORT	1.000	PC	VE1530A0	GOLD THERMOMETE R BLUE LIGHT COVER	1.000	PC	VE1535A1	230V WHITE LED	1.000	PC	VM1762A0	INNER LAMP SUPPORT	1.000	PC	VM2009A0	D16 SILVER ELLIPTICAL SUPPORT	1.000	PC
					Code	Description	Qty	UOM																					
					VE1170A0	D16 OPAQUE NICKEL ELLIPTICAL SUPPORT	1.000	PC																					
					VE1530A0	GOLD THERMOMETE R BLUE LIGHT COVER	1.000	PC																					
					VE1535A1	230V WHITE LED	1.000	PC																					
					VM1762A0	INNER LAMP SUPPORT	1.000	PC																					
VM2009A0	D16 SILVER ELLIPTICAL SUPPORT	1.000	PC																										
<table border="1"> <thead> <tr> <th>Code</th> <th>Description</th> <th>Qty</th> <th>UOM</th> </tr> </thead> <tbody> <tr> <td>VE1535A1</td> <td>230V WHITE LED</td> <td>1.000</td> <td>PC</td> </tr> </tbody> </table>	Code	Description	Qty	UOM	VE1535A1	230V WHITE LED	1.000	PC																					
Code	Description	Qty	UOM																										
VE1535A1	230V WHITE LED	1.000	PC																										
<table border="1"> <thead> <tr> <th>Code</th> <th>Description</th> <th>Qty</th> <th>UOM</th> </tr> </thead> <tbody> <tr> <td>VE1170A0</td> <td>D16 OPAQUE NICKEL ELLIPTICAL SUPPORT</td> <td>1.000</td> <td>PC</td> </tr> <tr> <td>VE1535A1</td> <td>230V WHITE LED</td> <td>1.000</td> <td>PC</td> </tr> <tr> <td>VM1762A0</td> <td>INNER LAMP SUPPORT</td> <td>1.000</td> <td>PC</td> </tr> <tr> <td>VM1903A0</td> <td>GREEN PILOT WITH GOLD "CLOUD"</td> <td>1.000</td> <td>PC</td> </tr> </tbody> </table>	Code	Description	Qty	UOM	VE1170A0	D16 OPAQUE NICKEL ELLIPTICAL SUPPORT	1.000	PC	VE1535A1	230V WHITE LED	1.000	PC	VM1762A0	INNER LAMP SUPPORT	1.000	PC	VM1903A0	GREEN PILOT WITH GOLD "CLOUD"	1.000	PC									
Code	Description	Qty	UOM																										
VE1170A0	D16 OPAQUE NICKEL ELLIPTICAL SUPPORT	1.000	PC																										
VE1535A1	230V WHITE LED	1.000	PC																										
VM1762A0	INNER LAMP SUPPORT	1.000	PC																										
VM1903A0	GREEN PILOT WITH GOLD "CLOUD"	1.000	PC																										
<table border="1"> <thead> <tr> <th>Code</th> <th>Description</th> <th>Qty</th> <th>UOM</th> </tr> </thead> <tbody> <tr> <td>VE1170A0</td> <td>D16 OPAQUE NICKEL ELLIPTICAL SUPPORT</td> <td>1.000</td> <td>PC</td> </tr> <tr> <td>VE1535A1</td> <td>230V WHITE LED</td> <td>1.000</td> <td>PC</td> </tr> <tr> <td>VM1762A0</td> <td>INNER LAMP SUPPORT</td> <td>1.000</td> <td>PC</td> </tr> <tr> <td>VM1903A0</td> <td>GREEN PILOT WITH GOLD "CLOUD"</td> <td>1.000</td> <td>PC</td> </tr> </tbody> </table>	Code	Description	Qty	UOM	VE1170A0	D16 OPAQUE NICKEL ELLIPTICAL SUPPORT	1.000	PC	VE1535A1	230V WHITE LED	1.000	PC	VM1762A0	INNER LAMP SUPPORT	1.000	PC	VM1903A0	GREEN PILOT WITH GOLD "CLOUD"	1.000	PC									
Code	Description	Qty	UOM																										
VE1170A0	D16 OPAQUE NICKEL ELLIPTICAL SUPPORT	1.000	PC																										
VE1535A1	230V WHITE LED	1.000	PC																										
VM1762A0	INNER LAMP SUPPORT	1.000	PC																										
VM1903A0	GREEN PILOT WITH GOLD "CLOUD"	1.000	PC																										
<table border="1"> <thead> <tr> <th>Code</th> <th>Description</th> <th>Qty</th> <th>UOM</th> </tr> </thead> <tbody> <tr> <td>VE1170A0</td> <td>D16 OPAQUE NICKEL ELLIPTICAL SUPPORT</td> <td>1.000</td> <td>PC</td> </tr> <tr> <td>VE1535A1</td> <td>230V WHITE LED</td> <td>1.000</td> <td>PC</td> </tr> <tr> <td>VM1762A0</td> <td>INNER LAMP SUPPORT</td> <td>1.000</td> <td>PC</td> </tr> <tr> <td>VM1903A0</td> <td>GREEN PILOT WITH GOLD "CLOUD"</td> <td>1.000</td> <td>PC</td> </tr> </tbody> </table>	Code	Description	Qty	UOM	VE1170A0	D16 OPAQUE NICKEL ELLIPTICAL SUPPORT	1.000	PC	VE1535A1	230V WHITE LED	1.000	PC	VM1762A0	INNER LAMP SUPPORT	1.000	PC	VM1903A0	GREEN PILOT WITH GOLD "CLOUD"	1.000	PC									
Code	Description	Qty	UOM																										
VE1170A0	D16 OPAQUE NICKEL ELLIPTICAL SUPPORT	1.000	PC																										
VE1535A1	230V WHITE LED	1.000	PC																										
VM1762A0	INNER LAMP SUPPORT	1.000	PC																										
VM1903A0	GREEN PILOT WITH GOLD "CLOUD"	1.000	PC																										
<table border="1"> <thead> <tr> <th>Code</th> <th>Description</th> <th>Qty</th> <th>UOM</th> </tr> </thead> <tbody> <tr> <td>VE1170A0</td> <td>D16 OPAQUE NICKEL ELLIPTICAL SUPPORT</td> <td>1.000</td> <td>PC</td> </tr> <tr> <td>VE1535A1</td> <td>230V WHITE LED</td> <td>1.000</td> <td>PC</td> </tr> <tr> <td>VM1762A0</td> <td>INNER LAMP SUPPORT</td> <td>1.000</td> <td>PC</td> </tr> <tr> <td>VM1903A0</td> <td>GREEN PILOT WITH GOLD "CLOUD"</td> <td>1.000</td> <td>PC</td> </tr> </tbody> </table>	Code	Description	Qty	UOM	VE1170A0	D16 OPAQUE NICKEL ELLIPTICAL SUPPORT	1.000	PC	VE1535A1	230V WHITE LED	1.000	PC	VM1762A0	INNER LAMP SUPPORT	1.000	PC	VM1903A0	GREEN PILOT WITH GOLD "CLOUD"	1.000	PC									
Code	Description	Qty	UOM																										
VE1170A0	D16 OPAQUE NICKEL ELLIPTICAL SUPPORT	1.000	PC																										
VE1535A1	230V WHITE LED	1.000	PC																										
VM1762A0	INNER LAMP SUPPORT	1.000	PC																										
VM1903A0	GREEN PILOT WITH GOLD "CLOUD"	1.000	PC																										
VE1535A	230V WHITE LED		KVE1535A	230V WHITE LED LIGHT 1 PC KIT	<table border="1"> <thead> <tr> <th>Code</th> <th>Description</th> <th>Qty</th> <th>UOM</th> </tr> </thead> <tbody> <tr> <td>VE1535A1</td> <td>230V WHITE LED</td> <td>1.000</td> <td>PC</td> </tr> </tbody> </table>	Code	Description	Qty	UOM	VE1535A1	230V WHITE LED	1.000	PC																
Code	Description	Qty	UOM																										
VE1535A1	230V WHITE LED	1.000	PC																										
			KVE0105A	CLOUD LED LIGHT+COVER+SUP PORT KIT	<table border="1"> <thead> <tr> <th>Code</th> <th>Description</th> <th>Qty</th> <th>UOM</th> </tr> </thead> <tbody> <tr> <td>VE1170A0</td> <td>D16 OPAQUE NICKEL ELLIPTICAL SUPPORT</td> <td>1.000</td> <td>PC</td> </tr> <tr> <td>VE1535A1</td> <td>230V WHITE LED</td> <td>1.000</td> <td>PC</td> </tr> <tr> <td>VM1762A0</td> <td>INNER LAMP SUPPORT</td> <td>1.000</td> <td>PC</td> </tr> <tr> <td>VM1903A0</td> <td>GREEN PILOT WITH GOLD "CLOUD"</td> <td>1.000</td> <td>PC</td> </tr> </tbody> </table>	Code	Description	Qty	UOM	VE1170A0	D16 OPAQUE NICKEL ELLIPTICAL SUPPORT	1.000	PC	VE1535A1	230V WHITE LED	1.000	PC	VM1762A0	INNER LAMP SUPPORT	1.000	PC	VM1903A0	GREEN PILOT WITH GOLD "CLOUD"	1.000	PC				
Code	Description	Qty	UOM																										
VE1170A0	D16 OPAQUE NICKEL ELLIPTICAL SUPPORT	1.000	PC																										
VE1535A1	230V WHITE LED	1.000	PC																										
VM1762A0	INNER LAMP SUPPORT	1.000	PC																										
VM1903A0	GREEN PILOT WITH GOLD "CLOUD"	1.000	PC																										

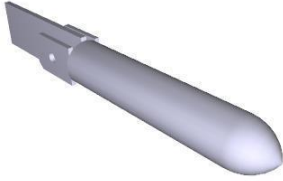

COMPONENT			SPARE PART																						
Code	Description	Image	Code	Description	Kit components																				
VE1535A	230V WHITE LED		KVE0104A	NEUTRAL GREEN LIGHT KIT	<table border="1"> <thead> <tr> <th>Code</th> <th>Description</th> <th>Qty</th> <th>UOM</th> </tr> </thead> <tbody> <tr> <td>VE1170A0</td> <td>D16 OPAQUE NICKEL ELLIPTICAL SUPPORT</td> <td>1.000</td> <td>PC</td> </tr> <tr> <td>VE1535A1</td> <td>230V WHITE LED</td> <td>1.000</td> <td>PC</td> </tr> <tr> <td>VM1782A0</td> <td>INNER LAMP SUPPORT</td> <td>1.000</td> <td>PC</td> </tr> <tr> <td>VM1902A0</td> <td>NEUTRAL GREEN PLASTIC COVER FOR</td> <td>1.000</td> <td>PC</td> </tr> </tbody> </table>	Code	Description	Qty	UOM	VE1170A0	D16 OPAQUE NICKEL ELLIPTICAL SUPPORT	1.000	PC	VE1535A1	230V WHITE LED	1.000	PC	VM1782A0	INNER LAMP SUPPORT	1.000	PC	VM1902A0	NEUTRAL GREEN PLASTIC COVER FOR	1.000	PC
			Code	Description	Qty	UOM																			
			VE1170A0	D16 OPAQUE NICKEL ELLIPTICAL SUPPORT	1.000	PC																			
			VE1535A1	230V WHITE LED	1.000	PC																			
VM1782A0	INNER LAMP SUPPORT	1.000	PC																						
VM1902A0	NEUTRAL GREEN PLASTIC COVER FOR	1.000	PC																						
KVE0102A	GOLDEN FLAME LIGHT COVER KIT	<table border="1"> <thead> <tr> <th>Code</th> <th>Description</th> <th>Qty</th> <th>UOM</th> </tr> </thead> <tbody> <tr> <td>VE1170A0</td> <td>D16 OPAQUE NICKEL ELLIPTICAL SUPPORT</td> <td>1.000</td> <td>PC</td> </tr> <tr> <td>VE1535A1</td> <td>230V WHITE LED</td> <td>1.000</td> <td>PC</td> </tr> <tr> <td>VM1782A0</td> <td>INNER LAMP SUPPORT</td> <td>1.000</td> <td>PC</td> </tr> <tr> <td>VM1787A0</td> <td>GREEN PILOT LIGHT W/ GOLD FLAME</td> <td>1.000</td> <td>PC</td> </tr> </tbody> </table>	Code	Description	Qty	UOM	VE1170A0	D16 OPAQUE NICKEL ELLIPTICAL SUPPORT	1.000	PC	VE1535A1	230V WHITE LED	1.000	PC	VM1782A0	INNER LAMP SUPPORT	1.000	PC	VM1787A0	GREEN PILOT LIGHT W/ GOLD FLAME	1.000	PC			
Code	Description	Qty	UOM																						
VE1170A0	D16 OPAQUE NICKEL ELLIPTICAL SUPPORT	1.000	PC																						
VE1535A1	230V WHITE LED	1.000	PC																						
VM1782A0	INNER LAMP SUPPORT	1.000	PC																						
VM1787A0	GREEN PILOT LIGHT W/ GOLD FLAME	1.000	PC																						
KVE0101A	SINUSOID LIGHT GREEN COVER KIT	<table border="1"> <thead> <tr> <th>Code</th> <th>Description</th> <th>Qty</th> <th>UOM</th> </tr> </thead> <tbody> <tr> <td>VE1170A0</td> <td>D16 OPAQUE NICKEL ELLIPTICAL SUPPORT</td> <td>1.000</td> <td>PC</td> </tr> <tr> <td>VE1535A1</td> <td>230V WHITE LED</td> <td>1.000</td> <td>PC</td> </tr> <tr> <td>VM1782A0</td> <td>INNER LAMP SUPPORT</td> <td>1.000</td> <td>PC</td> </tr> <tr> <td>VM1785A0</td> <td>GREEN PILOT WITH GOLD SINUSOIDE</td> <td>1.000</td> <td>PC</td> </tr> </tbody> </table>	Code	Description	Qty	UOM	VE1170A0	D16 OPAQUE NICKEL ELLIPTICAL SUPPORT	1.000	PC	VE1535A1	230V WHITE LED	1.000	PC	VM1782A0	INNER LAMP SUPPORT	1.000	PC	VM1785A0	GREEN PILOT WITH GOLD SINUSOIDE	1.000	PC			
Code	Description	Qty	UOM																						
VE1170A0	D16 OPAQUE NICKEL ELLIPTICAL SUPPORT	1.000	PC																						
VE1535A1	230V WHITE LED	1.000	PC																						
VM1782A0	INNER LAMP SUPPORT	1.000	PC																						
VM1785A0	GREEN PILOT WITH GOLD SINUSOIDE	1.000	PC																						
KVE0100A	THERMOMETER LIGHT COVER KIT	<table border="1"> <thead> <tr> <th>Code</th> <th>Description</th> <th>Qty</th> <th>UOM</th> </tr> </thead> <tbody> <tr> <td>VE1530A0</td> <td>GOLD THERMOMETE R BLUE LIGHT COVER</td> <td>1.000</td> <td>PC</td> </tr> <tr> <td>VE1535A1</td> <td>230V WHITE LED</td> <td>1.000</td> <td>PC</td> </tr> <tr> <td>VM1781A0</td> <td>D16 BLACK ELLIPTICAL SUPPORT</td> <td>1.000</td> <td>PC</td> </tr> <tr> <td>VM1782A0</td> <td>INNER LAMP SUPPORT</td> <td>1.000</td> <td>PC</td> </tr> </tbody> </table>	Code	Description	Qty	UOM	VE1530A0	GOLD THERMOMETE R BLUE LIGHT COVER	1.000	PC	VE1535A1	230V WHITE LED	1.000	PC	VM1781A0	D16 BLACK ELLIPTICAL SUPPORT	1.000	PC	VM1782A0	INNER LAMP SUPPORT	1.000	PC			
Code	Description	Qty	UOM																						
VE1530A0	GOLD THERMOMETE R BLUE LIGHT COVER	1.000	PC																						
VE1535A1	230V WHITE LED	1.000	PC																						
VM1781A0	D16 BLACK ELLIPTICAL SUPPORT	1.000	PC																						
VM1782A0	INNER LAMP SUPPORT	1.000	PC																						

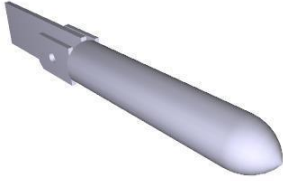

COMPONENT			SPARE PART																																						
Code	Description	Image	Code	Description	Kit components																																				
VE1535A	230V WHITE LED		KVE0011A	SP KNOBS AND LIGHTS KIT	<table border="1"> <thead> <tr> <th>Code</th> <th>Description</th> <th>Qty</th> <th>UOM</th> </tr> </thead> <tbody> <tr> <td>MN1105A0</td> <td>120-400C XP THERMOSTAT KNOB</td> <td>1.000</td> <td>PC</td> </tr> <tr> <td>MN1110A0</td> <td>XP NEUTRAL INDEX DIAL</td> <td>1.000</td> <td>PC</td> </tr> <tr> <td>VE1530A0</td> <td>GOLD THERMOMETE R BLUE LIGHT COVER</td> <td>1.000</td> <td>PC</td> </tr> <tr> <td>VE1535A1</td> <td>230V WHITE LED</td> <td>1.000</td> <td>PC</td> </tr> <tr> <td>VE1561A0</td> <td>NA/NA BIPOLAR SWITCH</td> <td>1.000</td> <td>PC</td> </tr> <tr> <td>VM1761A0</td> <td>D16 BLACK ELLIPTICAL SUPPORT</td> <td>2.000</td> <td>PC</td> </tr> <tr> <td>VM1762A0</td> <td>INNER LAMP SUPPORT</td> <td>1.000</td> <td>PC</td> </tr> <tr> <td>VM1776A0</td> <td>"GOLD "0-1" MATT SILVER KEY"</td> <td>1.000</td> <td>PC</td> </tr> </tbody> </table>	Code	Description	Qty	UOM	MN1105A0	120-400C XP THERMOSTAT KNOB	1.000	PC	MN1110A0	XP NEUTRAL INDEX DIAL	1.000	PC	VE1530A0	GOLD THERMOMETE R BLUE LIGHT COVER	1.000	PC	VE1535A1	230V WHITE LED	1.000	PC	VE1561A0	NA/NA BIPOLAR SWITCH	1.000	PC	VM1761A0	D16 BLACK ELLIPTICAL SUPPORT	2.000	PC	VM1762A0	INNER LAMP SUPPORT	1.000	PC	VM1776A0	"GOLD "0-1" MATT SILVER KEY"	1.000	PC
			Code	Description	Qty	UOM																																			
			MN1105A0	120-400C XP THERMOSTAT KNOB	1.000	PC																																			
MN1110A0	XP NEUTRAL INDEX DIAL	1.000	PC																																						
VE1530A0	GOLD THERMOMETE R BLUE LIGHT COVER	1.000	PC																																						
VE1535A1	230V WHITE LED	1.000	PC																																						
VE1561A0	NA/NA BIPOLAR SWITCH	1.000	PC																																						
VM1761A0	D16 BLACK ELLIPTICAL SUPPORT	2.000	PC																																						
VM1762A0	INNER LAMP SUPPORT	1.000	PC																																						
VM1776A0	"GOLD "0-1" MATT SILVER KEY"	1.000	PC																																						
KVE0008A	XL PILOT BLUE LIGHTS KIT	<table border="1"> <thead> <tr> <th>Code</th> <th>Description</th> <th>Qty</th> <th>UOM</th> </tr> </thead> <tbody> <tr> <td>VE1170A0</td> <td>D16 OPAQUE NICKEL ELLIPTICAL SUPPORT</td> <td>3.000</td> <td>PC</td> </tr> <tr> <td>VE1530A0</td> <td>GOLD THERMOMETE R BLUE LIGHT COVER</td> <td>1.000</td> <td>PC</td> </tr> <tr> <td>VE1535A1</td> <td>230V WHITE LED</td> <td>1.000</td> <td>PC</td> </tr> <tr> <td>VE1561A0</td> <td>NA/NA BIPOLAR SWITCH</td> <td>1.000</td> <td>PC</td> </tr> <tr> <td>VE1562A0</td> <td>UNIPOLAR NA PUSH BUTTO</td> <td>1.000</td> <td>PC</td> </tr> <tr> <td>VM1762A0</td> <td>INNER LAMP SUPPORT</td> <td>1.000</td> <td>PC</td> </tr> <tr> <td>VM1775A0</td> <td>OPAQUE SILVER KEY WITH GOLD CLOUD</td> <td>1.000</td> <td>PC</td> </tr> <tr> <td>VM1776A0</td> <td>"GOLD "0-1" MATT SILVER KEY"</td> <td>1.000</td> <td>PC</td> </tr> </tbody> </table>	Code	Description	Qty	UOM	VE1170A0	D16 OPAQUE NICKEL ELLIPTICAL SUPPORT	3.000	PC	VE1530A0	GOLD THERMOMETE R BLUE LIGHT COVER	1.000	PC	VE1535A1	230V WHITE LED	1.000	PC	VE1561A0	NA/NA BIPOLAR SWITCH	1.000	PC	VE1562A0	UNIPOLAR NA PUSH BUTTO	1.000	PC	VM1762A0	INNER LAMP SUPPORT	1.000	PC	VM1775A0	OPAQUE SILVER KEY WITH GOLD CLOUD	1.000	PC	VM1776A0	"GOLD "0-1" MATT SILVER KEY"	1.000	PC			
Code	Description	Qty	UOM																																						
VE1170A0	D16 OPAQUE NICKEL ELLIPTICAL SUPPORT	3.000	PC																																						
VE1530A0	GOLD THERMOMETE R BLUE LIGHT COVER	1.000	PC																																						
VE1535A1	230V WHITE LED	1.000	PC																																						
VE1561A0	NA/NA BIPOLAR SWITCH	1.000	PC																																						
VE1562A0	UNIPOLAR NA PUSH BUTTO	1.000	PC																																						
VM1762A0	INNER LAMP SUPPORT	1.000	PC																																						
VM1775A0	OPAQUE SILVER KEY WITH GOLD CLOUD	1.000	PC																																						
VM1776A0	"GOLD "0-1" MATT SILVER KEY"	1.000	PC																																						
KVE0007A	XF-XG LED AND LED COVERS KIT	<table border="1"> <thead> <tr> <th>Code</th> <th>Description</th> <th>Qty</th> <th>UOM</th> </tr> </thead> <tbody> <tr> <td>VE1170A0</td> <td>D16 OPAQUE NICKEL ELLIPTICAL SUPPORT</td> <td>5.000</td> <td>PC</td> </tr> </tbody> </table>	Code	Description	Qty	UOM	VE1170A0	D16 OPAQUE NICKEL ELLIPTICAL SUPPORT	5.000	PC																															
Code	Description	Qty	UOM																																						
VE1170A0	D16 OPAQUE NICKEL ELLIPTICAL SUPPORT	5.000	PC																																						



COMPONENT			SPARE PART																																														
Code	Description	Image	Code	Description	Kit components																																												
VE1535A	230V WHITE LED		KVE0007A	XF-XG LED AND LED COVERS KIT	<table border="1"> <thead> <tr> <th>Code</th> <th>Description</th> <th>Qty</th> <th>UOM</th> </tr> </thead> <tbody> <tr> <td>VE1530A0</td> <td>GOLD THERMOMETE R BLUE LIGHT COVER</td> <td>1.000</td> <td>PC</td> </tr> <tr> <td>VE1535A1</td> <td>230V WHITE LED</td> <td>1.000</td> <td>PC</td> </tr> <tr> <td>VE1562A0</td> <td>UNIPOLAR NA PUSH BUTTO</td> <td>1.000</td> <td>PC</td> </tr> <tr> <td>VE1585A0</td> <td>BLUE LIGHT COVER GOLD SINUSOID</td> <td>1.000</td> <td>PC</td> </tr> <tr> <td>VM1762A0</td> <td>INNER LAMP SUPPORT</td> <td>4.000</td> <td>PC</td> </tr> <tr> <td>VM1767A0</td> <td>GREEN PILOT LIGHT W/ GOLD FLAME</td> <td>1.000</td> <td>PC</td> </tr> <tr> <td>VM1774A0</td> <td>SILVER OPAQUE KEY W/ GOLD FLAME</td> <td>1.000</td> <td>PC</td> </tr> <tr> <td>VM1775A0</td> <td>OPAQUE SILVER KEY WITH GOLD CLOUD</td> <td>1.000</td> <td>PC</td> </tr> <tr> <td>VM1902A0</td> <td>NEUTRAL GREEN PLASTIC COVER FOR</td> <td>1.000</td> <td>PC</td> </tr> <tr> <td>VM1903A0</td> <td>GREEN PILOT WITH GOLD "CLOUD"</td> <td>1.000</td> <td>PC</td> </tr> </tbody> </table>	Code	Description	Qty	UOM	VE1530A0	GOLD THERMOMETE R BLUE LIGHT COVER	1.000	PC	VE1535A1	230V WHITE LED	1.000	PC	VE1562A0	UNIPOLAR NA PUSH BUTTO	1.000	PC	VE1585A0	BLUE LIGHT COVER GOLD SINUSOID	1.000	PC	VM1762A0	INNER LAMP SUPPORT	4.000	PC	VM1767A0	GREEN PILOT LIGHT W/ GOLD FLAME	1.000	PC	VM1774A0	SILVER OPAQUE KEY W/ GOLD FLAME	1.000	PC	VM1775A0	OPAQUE SILVER KEY WITH GOLD CLOUD	1.000	PC	VM1902A0	NEUTRAL GREEN PLASTIC COVER FOR	1.000	PC	VM1903A0	GREEN PILOT WITH GOLD "CLOUD"	1.000	PC
			Code	Description	Qty	UOM																																											
			VE1530A0	GOLD THERMOMETE R BLUE LIGHT COVER	1.000	PC																																											
VE1535A1	230V WHITE LED	1.000	PC																																														
VE1562A0	UNIPOLAR NA PUSH BUTTO	1.000	PC																																														
VE1585A0	BLUE LIGHT COVER GOLD SINUSOID	1.000	PC																																														
VM1762A0	INNER LAMP SUPPORT	4.000	PC																																														
VM1767A0	GREEN PILOT LIGHT W/ GOLD FLAME	1.000	PC																																														
VM1774A0	SILVER OPAQUE KEY W/ GOLD FLAME	1.000	PC																																														
VM1775A0	OPAQUE SILVER KEY WITH GOLD CLOUD	1.000	PC																																														
VM1902A0	NEUTRAL GREEN PLASTIC COVER FOR	1.000	PC																																														
VM1903A0	GREEN PILOT WITH GOLD "CLOUD"	1.000	PC																																														
KLP1014A	SINUSOID LED LIGHT+COVER+SUPPORT KIT	<table border="1"> <thead> <tr> <th>Code</th> <th>Description</th> <th>Qty</th> <th>UOM</th> </tr> </thead> <tbody> <tr> <td>VE1170A0</td> <td>D16 OPAQUE NICKEL ELLIPTICAL SUPPORT</td> <td>2.000</td> <td>PC</td> </tr> <tr> <td>VE1535A1</td> <td>230V WHITE LED</td> <td>2.000</td> <td>PC</td> </tr> <tr> <td>VE1585A0</td> <td>BLUE LIGHT COVER GOLD SINUSOID</td> <td>2.000</td> <td>PC</td> </tr> <tr> <td>VM1762A0</td> <td>INNER LAMP SUPPORT</td> <td>2.000</td> <td>PC</td> </tr> <tr> <td>VM2009A0</td> <td>D16 SILVER ELLIPTICAL SUPPORT</td> <td>1.000</td> <td>PC</td> </tr> </tbody> </table>	Code	Description	Qty	UOM	VE1170A0	D16 OPAQUE NICKEL ELLIPTICAL SUPPORT	2.000	PC	VE1535A1	230V WHITE LED	2.000	PC	VE1585A0	BLUE LIGHT COVER GOLD SINUSOID	2.000	PC	VM1762A0	INNER LAMP SUPPORT	2.000	PC	VM2009A0	D16 SILVER ELLIPTICAL SUPPORT	1.000	PC																							
Code	Description	Qty	UOM																																														
VE1170A0	D16 OPAQUE NICKEL ELLIPTICAL SUPPORT	2.000	PC																																														
VE1535A1	230V WHITE LED	2.000	PC																																														
VE1585A0	BLUE LIGHT COVER GOLD SINUSOID	2.000	PC																																														
VM1762A0	INNER LAMP SUPPORT	2.000	PC																																														
VM2009A0	D16 SILVER ELLIPTICAL SUPPORT	1.000	PC																																														
KLP1012A	GOLDEN THERMOMETER BLUE LIGHT KIT	<table border="1"> <thead> <tr> <th>Code</th> <th>Description</th> <th>Qty</th> <th>UOM</th> </tr> </thead> <tbody> <tr> <td>VE1170A0</td> <td>D16 OPAQUE NICKEL ELLIPTICAL SUPPORT</td> <td>1.000</td> <td>PC</td> </tr> </tbody> </table>	Code	Description	Qty	UOM	VE1170A0	D16 OPAQUE NICKEL ELLIPTICAL SUPPORT	1.000	PC																																							
Code	Description	Qty	UOM																																														
VE1170A0	D16 OPAQUE NICKEL ELLIPTICAL SUPPORT	1.000	PC																																														

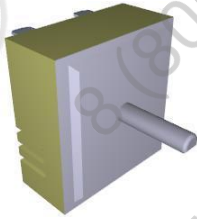
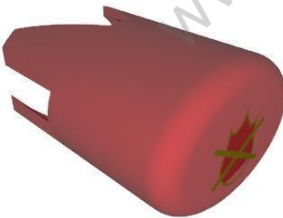

COMPONENT			SPARE PART																						
Code	Description	Image	Code	Description	Kit components																				
VE1535A	230V WHITE LED		KLP1012A	GOLDEN THERMOMETER BLUE LIGHT KIT	<table border="1"> <thead> <tr> <th>Code</th> <th>Description</th> <th>Qty</th> <th>UOM</th> </tr> </thead> <tbody> <tr> <td>VE1530A0</td> <td>GOLD THERMOMETE R BLUE LIGHT COVER</td> <td>1.000</td> <td>PC</td> </tr> <tr> <td>VE1535A1</td> <td>230V WHITE LED</td> <td>1.000</td> <td>PC</td> </tr> <tr> <td>VM1762A0</td> <td>INNER LAMP SUPPORT</td> <td>1.000</td> <td>PC</td> </tr> <tr> <td>VM2009A0</td> <td>D16 SILVER ELLIPTICAL SUPPORT</td> <td>1.000</td> <td>PC</td> </tr> </tbody> </table>	Code	Description	Qty	UOM	VE1530A0	GOLD THERMOMETE R BLUE LIGHT COVER	1.000	PC	VE1535A1	230V WHITE LED	1.000	PC	VM1762A0	INNER LAMP SUPPORT	1.000	PC	VM2009A0	D16 SILVER ELLIPTICAL SUPPORT	1.000	PC
					Code	Description	Qty	UOM																	
VE1530A0	GOLD THERMOMETE R BLUE LIGHT COVER	1.000	PC																						
VE1535A1	230V WHITE LED	1.000	PC																						
VM1762A0	INNER LAMP SUPPORT	1.000	PC																						
VM2009A0	D16 SILVER ELLIPTICAL SUPPORT	1.000	PC																						
<table border="1"> <thead> <tr> <th>Code</th> <th>Description</th> <th>Qty</th> <th>UOM</th> </tr> </thead> <tbody> <tr> <td>VE1170A0</td> <td>D16 OPAQUE NICKEL ELLIPTICAL SUPPORT</td> <td>1.000</td> <td>PC</td> </tr> <tr> <td>VE1535A1</td> <td>230V WHITE LED</td> <td>1.000</td> <td>PC</td> </tr> <tr> <td>VM1762A0</td> <td>INNER LAMP SUPPORT</td> <td>1.000</td> <td>PC</td> </tr> <tr> <td>VM1764A0</td> <td>GREEN PILOT WITH GOLD THERMOMETE</td> <td>1.000</td> <td>PC</td> </tr> </tbody> </table>	Code	Description	Qty	UOM	VE1170A0	D16 OPAQUE NICKEL ELLIPTICAL SUPPORT	1.000	PC	VE1535A1	230V WHITE LED	1.000	PC	VM1762A0	INNER LAMP SUPPORT	1.000	PC	VM1764A0	GREEN PILOT WITH GOLD THERMOMETE	1.000	PC					
Code	Description	Qty	UOM																						
VE1170A0	D16 OPAQUE NICKEL ELLIPTICAL SUPPORT	1.000	PC																						
VE1535A1	230V WHITE LED	1.000	PC																						
VM1762A0	INNER LAMP SUPPORT	1.000	PC																						
VM1764A0	GREEN PILOT WITH GOLD THERMOMETE	1.000	PC																						
VE1556A	THERMAL SWITCH 240V		KVE1556A	ENERGY REGULATOR KIT	<table border="1"> <thead> <tr> <th>Code</th> <th>Description</th> <th>Qty</th> <th>UOM</th> </tr> </thead> <tbody> <tr> <td>VE1556A0</td> <td>THERMAL SWITCH 240V</td> <td>1.000</td> <td>PC</td> </tr> <tr> <td>VH1850A0</td> <td>TCB M4x6 SCREW</td> <td>2.000</td> <td>PC</td> </tr> </tbody> </table>	Code	Description	Qty	UOM	VE1556A0	THERMAL SWITCH 240V	1.000	PC	VH1850A0	TCB M4x6 SCREW	2.000	PC								
					Code	Description	Qty	UOM																	
VE1556A0	THERMAL SWITCH 240V	1.000	PC																						
VH1850A0	TCB M4x6 SCREW	2.000	PC																						
VE1624B	RED PILOT LIGHT W/ GOLD FLAME		KLP1059A	GOLDEN FLAME RED LIGHT KIT	<table border="1"> <thead> <tr> <th>Code</th> <th>Description</th> <th>Qty</th> <th>UOM</th> </tr> </thead> <tbody> <tr> <td>VE1535A1</td> <td>230V WHITE LED</td> <td>1.000</td> <td>PC</td> </tr> <tr> <td>VE1624B0</td> <td>RED PILOT LIGHT W/ GOLD FLAME</td> <td>1.000</td> <td>PC</td> </tr> <tr> <td>VM1762A0</td> <td>INNER LAMP SUPPORT</td> <td>1.000</td> <td>PC</td> </tr> <tr> <td>VM2009A0</td> <td>D16 SILVER ELLIPTICAL SUPPORT</td> <td>1.000</td> <td>PC</td> </tr> </tbody> </table>	Code	Description	Qty	UOM	VE1535A1	230V WHITE LED	1.000	PC	VE1624B0	RED PILOT LIGHT W/ GOLD FLAME	1.000	PC	VM1762A0	INNER LAMP SUPPORT	1.000	PC	VM2009A0	D16 SILVER ELLIPTICAL SUPPORT	1.000	PC
					Code	Description	Qty	UOM																	
VE1535A1	230V WHITE LED	1.000	PC																						
VE1624B0	RED PILOT LIGHT W/ GOLD FLAME	1.000	PC																						
VM1762A0	INNER LAMP SUPPORT	1.000	PC																						
VM2009A0	D16 SILVER ELLIPTICAL SUPPORT	1.000	PC																						



COMPONENT			SPARE PART																																														
Code	Description	Image	Code	Description	Kit components																																												
VM1762A	INNER LAMP SUPPORT		KVM1762A	LAMP INTERNAL SUPPORT KIT	<table border="1"> <thead> <tr> <th>Code</th> <th>Description</th> <th>Qty</th> <th>UOM</th> </tr> </thead> <tbody> <tr> <td>VM1762A0</td> <td>INNER LAMP SUPPORT</td> <td>1.000</td> <td>PC</td> </tr> </tbody> </table>	Code	Description	Qty	UOM	VM1762A0	INNER LAMP SUPPORT	1.000	PC																																				
Code	Description	Qty	UOM																																														
VM1762A0	INNER LAMP SUPPORT	1.000	PC																																														
VM1972A	BAKERLUX/CHEFLUX MANUAL CONTROL PANEL		KVM1972A	CL/BL MANUAL CONTROL BOARD KIT	<table border="1"> <thead> <tr> <th>Code</th> <th>Description</th> <th>Qty</th> <th>UOM</th> </tr> </thead> <tbody> <tr> <td>VE1530A0</td> <td>GOLD THERMOMETE R BLUE LIGHT COVER</td> <td>1.000</td> <td>PC</td> </tr> <tr> <td>VE1535A1</td> <td>230V WHITE LED</td> <td>2.000</td> <td>PC</td> </tr> <tr> <td>VE1561A0</td> <td>NA/NA BIPOLAR SWITCH</td> <td>1.000</td> <td>PC</td> </tr> <tr> <td>VE1585A0</td> <td>BLUE LIGHT COVER GOLD SINUSOID</td> <td>1.000</td> <td>PC</td> </tr> <tr> <td>VM1762A0</td> <td>INNER LAMP SUPPORT</td> <td>2.000</td> <td>PC</td> </tr> <tr> <td>VM1794A0</td> <td>250x4.8 PA66 BLACK CLAMP</td> <td>2.000</td> <td>PC</td> </tr> <tr> <td>VM1972A0</td> <td>BAKERLUX/CH EFLUX MANUAL CONTROL PANEL</td> <td>1.000</td> <td>PC</td> </tr> <tr> <td>VM2007A0</td> <td>FAN SPEED SILVER BUTTON</td> <td>1.000</td> <td>PC</td> </tr> <tr> <td>VM2009A0</td> <td>D16 SILVER ELLIPTICAL SUPPORT</td> <td>3.000</td> <td>PC</td> </tr> <tr> <td>VM2103A0</td> <td>CLAMP LOCK</td> <td>2.000</td> <td>PC</td> </tr> </tbody> </table>	Code	Description	Qty	UOM	VE1530A0	GOLD THERMOMETE R BLUE LIGHT COVER	1.000	PC	VE1535A1	230V WHITE LED	2.000	PC	VE1561A0	NA/NA BIPOLAR SWITCH	1.000	PC	VE1585A0	BLUE LIGHT COVER GOLD SINUSOID	1.000	PC	VM1762A0	INNER LAMP SUPPORT	2.000	PC	VM1794A0	250x4.8 PA66 BLACK CLAMP	2.000	PC	VM1972A0	BAKERLUX/CH EFLUX MANUAL CONTROL PANEL	1.000	PC	VM2007A0	FAN SPEED SILVER BUTTON	1.000	PC	VM2009A0	D16 SILVER ELLIPTICAL SUPPORT	3.000	PC	VM2103A0	CLAMP LOCK	2.000	PC
Code	Description	Qty	UOM																																														
VE1530A0	GOLD THERMOMETE R BLUE LIGHT COVER	1.000	PC																																														
VE1535A1	230V WHITE LED	2.000	PC																																														
VE1561A0	NA/NA BIPOLAR SWITCH	1.000	PC																																														
VE1585A0	BLUE LIGHT COVER GOLD SINUSOID	1.000	PC																																														
VM1762A0	INNER LAMP SUPPORT	2.000	PC																																														
VM1794A0	250x4.8 PA66 BLACK CLAMP	2.000	PC																																														
VM1972A0	BAKERLUX/CH EFLUX MANUAL CONTROL PANEL	1.000	PC																																														
VM2007A0	FAN SPEED SILVER BUTTON	1.000	PC																																														
VM2009A0	D16 SILVER ELLIPTICAL SUPPORT	3.000	PC																																														
VM2103A0	CLAMP LOCK	2.000	PC																																														
VM2007A	FAN SPEED SILVER BUTTON		KVM2007A	FAN SPEED BUTTON KIT	<table border="1"> <thead> <tr> <th>Code</th> <th>Description</th> <th>Qty</th> <th>UOM</th> </tr> </thead> <tbody> <tr> <td>VM2007A0</td> <td>FAN SPEED SILVER BUTTON</td> <td>1.000</td> <td>PC</td> </tr> </tbody> </table>	Code	Description	Qty	UOM	VM2007A0	FAN SPEED SILVER BUTTON	1.000	PC																																				
Code	Description	Qty	UOM																																														
VM2007A0	FAN SPEED SILVER BUTTON	1.000	PC																																														



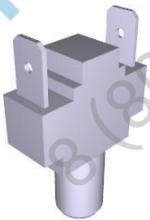

COMPONENT			SPARE PART																			
Code	Description	Image	Code	Description	Kit components																	
VM2009A	D16 SILVER ELLIPTICAL SUPPORT		KVM2009A	D16 SILVER ELLIPTICAL SUPPORT KIT	<table border="1"> <thead> <tr> <th>Code</th> <th>Description</th> <th>Qty</th> <th>UOM</th> </tr> </thead> <tbody> <tr> <td>VM2009A0</td> <td>D16 SILVER ELLIPTICAL SUPPORT</td> <td>1.000</td> <td>PC</td> </tr> </tbody> </table>	Code	Description	Qty	UOM	VM2009A0	D16 SILVER ELLIPTICAL SUPPORT	1.000	PC									
			Code	Description	Qty	UOM																
VM2009A0	D16 SILVER ELLIPTICAL SUPPORT	1.000	PC																			
KVM1019B	MANUAL PROVER CONTROL BOARD KIT	<table border="1"> <thead> <tr> <th>Code</th> <th>Description</th> <th>Qty</th> <th>UOM</th> </tr> </thead> <tbody> <tr> <td>MS1018B0</td> <td>MANUAL PROOFER CONTROL BOARD STICKER</td> <td>1.000</td> <td>PC</td> </tr> <tr> <td>MS1018C0</td> <td>MANUAL PROVER FRONT COVER (° C)</td> <td>1.000</td> <td>PC</td> </tr> <tr> <td>VM1019B0</td> <td>MANUAL PROOVER PLASTIC CONTROL PANEL</td> <td>1.000</td> <td>PC</td> </tr> <tr> <td>VM2009A0</td> <td>D16 SILVER ELLIPTICAL SUPPORT</td> <td>3.000</td> <td>PC</td> </tr> </tbody> </table>	Code	Description	Qty	UOM	MS1018B0	MANUAL PROOFER CONTROL BOARD STICKER	1.000	PC	MS1018C0	MANUAL PROVER FRONT COVER (° C)	1.000	PC	VM1019B0	MANUAL PROOVER PLASTIC CONTROL PANEL	1.000	PC	VM2009A0	D16 SILVER ELLIPTICAL SUPPORT	3.000	PC
Code	Description	Qty	UOM																			
MS1018B0	MANUAL PROOFER CONTROL BOARD STICKER	1.000	PC																			
MS1018C0	MANUAL PROVER FRONT COVER (° C)	1.000	PC																			
VM1019B0	MANUAL PROOVER PLASTIC CONTROL PANEL	1.000	PC																			
VM2009A0	D16 SILVER ELLIPTICAL SUPPORT	3.000	PC																			
VE1562A	UNIPOLAR NA PUSH BUTTON		KVE0107A	SILVER CLOUD KEY KIT	<table border="1"> <thead> <tr> <th>Code</th> <th>Description</th> <th>Qty</th> <th>UOM</th> </tr> </thead> <tbody> <tr> <td>VE1170A0</td> <td>D16 OPAQUE NICKEL ELLIPTICAL SUPPORT</td> <td>2.000</td> <td>PC</td> </tr> <tr> <td>VE1562A0</td> <td>UNIPOLAR NA PUSH BUTTO</td> <td>1.000</td> <td>PC</td> </tr> <tr> <td>VM1775A0</td> <td>OPAQUE SILVER KEY WITH GOLD CLOUD</td> <td>1.000</td> <td>PC</td> </tr> </tbody> </table>	Code	Description	Qty	UOM	VE1170A0	D16 OPAQUE NICKEL ELLIPTICAL SUPPORT	2.000	PC	VE1562A0	UNIPOLAR NA PUSH BUTTO	1.000	PC	VM1775A0	OPAQUE SILVER KEY WITH GOLD CLOUD	1.000	PC	
			Code	Description	Qty	UOM																
VE1170A0	D16 OPAQUE NICKEL ELLIPTICAL SUPPORT	2.000	PC																			
VE1562A0	UNIPOLAR NA PUSH BUTTO	1.000	PC																			
VM1775A0	OPAQUE SILVER KEY WITH GOLD CLOUD	1.000	PC																			
KVE0106A	SILVER FLAME LIGHT COVER KIT	<table border="1"> <thead> <tr> <th>Code</th> <th>Description</th> <th>Qty</th> <th>UOM</th> </tr> </thead> <tbody> <tr> <td>VE1170A0</td> <td>D16 OPAQUE NICKEL ELLIPTICAL SUPPORT</td> <td>1.000</td> <td>PC</td> </tr> <tr> <td>VE1562A0</td> <td>UNIPOLAR NA PUSH BUTTO</td> <td>1.000</td> <td>PC</td> </tr> <tr> <td>VM1774A0</td> <td>SILVER OPAQUE KEY W/ GOLD FLAME</td> <td>1.000</td> <td>PC</td> </tr> </tbody> </table>	Code	Description	Qty	UOM	VE1170A0	D16 OPAQUE NICKEL ELLIPTICAL SUPPORT	1.000	PC	VE1562A0	UNIPOLAR NA PUSH BUTTO	1.000	PC	VM1774A0	SILVER OPAQUE KEY W/ GOLD FLAME	1.000	PC				
Code	Description	Qty	UOM																			
VE1170A0	D16 OPAQUE NICKEL ELLIPTICAL SUPPORT	1.000	PC																			
VE1562A0	UNIPOLAR NA PUSH BUTTO	1.000	PC																			
VM1774A0	SILVER OPAQUE KEY W/ GOLD FLAME	1.000	PC																			

COMPONENT			SPARE PART																			
Code	Description	Image	Code	Description	Kit components																	
VM2009A	D16 SILVER ELLIPTICAL SUPPORT		KVM2009A	D16 SILVER ELLIPTICAL SUPPORT KIT	<table border="1"> <thead> <tr> <th>Code</th> <th>Description</th> <th>Qty</th> <th>UOM</th> </tr> </thead> <tbody> <tr> <td>VM2009A0</td> <td>D16 SILVER ELLIPTICAL SUPPORT</td> <td>1.000</td> <td>PC</td> </tr> </tbody> </table>	Code	Description	Qty	UOM	VM2009A0	D16 SILVER ELLIPTICAL SUPPORT	1.000	PC									
			Code	Description	Qty	UOM																
VM2009A0	D16 SILVER ELLIPTICAL SUPPORT	1.000	PC																			
KVM1019B	MANUAL PROVER CONTROL BOARD KIT	<table border="1"> <thead> <tr> <th>Code</th> <th>Description</th> <th>Qty</th> <th>UOM</th> </tr> </thead> <tbody> <tr> <td>MS1018B0</td> <td>MANUAL PROOVER CONTROL BOARD STICKER</td> <td>1.000</td> <td>PC</td> </tr> <tr> <td>MS1018C0</td> <td>MANUAL PROOVER FRONT COVER (° C)</td> <td>1.000</td> <td>PC</td> </tr> <tr> <td>VM1019B0</td> <td>MANUAL PROOVER PLASTIC CONTROL PANEL</td> <td>1.000</td> <td>PC</td> </tr> <tr> <td>VM2009A0</td> <td>D16 SILVER ELLIPTICAL SUPPORT</td> <td>3.000</td> <td>PC</td> </tr> </tbody> </table>	Code	Description	Qty	UOM	MS1018B0	MANUAL PROOVER CONTROL BOARD STICKER	1.000	PC	MS1018C0	MANUAL PROOVER FRONT COVER (° C)	1.000	PC	VM1019B0	MANUAL PROOVER PLASTIC CONTROL PANEL	1.000	PC	VM2009A0	D16 SILVER ELLIPTICAL SUPPORT	3.000	PC
Code	Description	Qty	UOM																			
MS1018B0	MANUAL PROOVER CONTROL BOARD STICKER	1.000	PC																			
MS1018C0	MANUAL PROOVER FRONT COVER (° C)	1.000	PC																			
VM1019B0	MANUAL PROOVER PLASTIC CONTROL PANEL	1.000	PC																			
VM2009A0	D16 SILVER ELLIPTICAL SUPPORT	3.000	PC																			
VM2078A	BLACK FLAME MATT SILVER BUTTON		VM2078A0	BLACK FLAME MATT SILVER BUTTON																		
EL1195B	Ø8F-Ø8M ELBOW CONNECTION		KEL1195A	D8F-D8M JG ELBOW FITTING 10 PCS KIT	<table border="1"> <thead> <tr> <th>Code</th> <th>Description</th> <th>Qty</th> <th>UOM</th> </tr> </thead> <tbody> <tr> <td>EL1195A0</td> <td>ELBOW UNION Ø8F-Ø8M</td> <td>10.000</td> <td>PC</td> </tr> </tbody> </table>	Code	Description	Qty	UOM	EL1195A0	ELBOW UNION Ø8F-Ø8M	10.000	PC									
Code	Description	Qty	UOM																			
EL1195A0	ELBOW UNION Ø8F-Ø8M	10.000	PC																			
GN1275A	XBC/XVC BLACK CHIMNEY SEALING		KGN1275A	KIT GUARNIZIONE CAMINO SILICONE NERO 4PZ	<table border="1"> <thead> <tr> <th>Code</th> <th>Description</th> <th>Qty</th> <th>UOM</th> </tr> </thead> <tbody> <tr> <td>GN1275A0</td> <td>XBC/XVC BLACK CHIMNEY SEALING</td> <td>4.000</td> <td>PC</td> </tr> </tbody> </table>	Code	Description	Qty	UOM	GN1275A0	XBC/XVC BLACK CHIMNEY SEALING	4.000	PC									
Code	Description	Qty	UOM																			
GN1275A0	XBC/XVC BLACK CHIMNEY SEALING	4.000	PC																			





COMPONENT			SPARE PART										
Code	Description	Image	Code	Description	Kit components								
RC1002A	JG 10M-8F TERMINAL REDUCTION FITTING		KRC1002A	JG Ø10M-Ø8F REDUCING SPIGOT 10 PCS KIT	<table border="1"> <thead> <tr> <th>Code</th> <th>Description</th> <th>Qty</th> <th>UOM</th> </tr> </thead> <tbody> <tr> <td>RC1002A0</td> <td>JG 10M-8F TERMINAL REDUCTION FITTING</td> <td>10.000</td> <td>PC</td> </tr> </tbody> </table>	Code	Description	Qty	UOM	RC1002A0	JG 10M-8F TERMINAL REDUCTION FITTING	10.000	PC
Code	Description	Qty	UOM										
RC1002A0	JG 10M-8F TERMINAL REDUCTION FITTING	10.000	PC										
TB2808A	TB1815A0-D8 H2O SOLENOID LUX 0,5M		TB2808A0	TB1815A0-D8 H2O SOLENOID LUX 0,5M									
VI1081A	M6X25 STAINLESS STEEL SCREW		KVI1081A	10PCS. M6x25 ST.STEEL SCREW KI	<table border="1"> <thead> <tr> <th>Code</th> <th>Description</th> <th>Qty</th> <th>UOM</th> </tr> </thead> <tbody> <tr> <td>VI1081A0</td> <td>M6X25 STAINLESS STEEL SCREW</td> <td>10.000</td> <td>PC</td> </tr> </tbody> </table>	Code	Description	Qty	UOM	VI1081A0	M6X25 STAINLESS STEEL SCREW	10.000	PC
Code	Description	Qty	UOM										
VI1081A0	M6X25 STAINLESS STEEL SCREW	10.000	PC										
VM1165B	CT BT DOOR UPPER BRACKET		KVM1165B	CT BT CL BL DOOR UPPER BRACKET KI	<table border="1"> <thead> <tr> <th>Code</th> <th>Description</th> <th>Qty</th> <th>UOM</th> </tr> </thead> <tbody> <tr> <td>VM1165B0</td> <td>CT BT DOOR UPPER BRACKET</td> <td>1.000</td> <td>PC</td> </tr> </tbody> </table>	Code	Description	Qty	UOM	VM1165B0	CT BT DOOR UPPER BRACKET	1.000	PC
Code	Description	Qty	UOM										
VM1165B0	CT BT DOOR UPPER BRACKET	1.000	PC										
VM1166A	CAP FOR DOOR UPPER STIRRUP XVC204/304/5		KVM1166A	DOOR UPPER BRACKET COVER KI	<table border="1"> <thead> <tr> <th>Code</th> <th>Description</th> <th>Qty</th> <th>UOM</th> </tr> </thead> <tbody> <tr> <td>VM1166A0</td> <td>CAP FOR DOOR UPPER STIRRUP XVC204/304/5</td> <td>1.000</td> <td>PC</td> </tr> </tbody> </table>	Code	Description	Qty	UOM	VM1166A0	CAP FOR DOOR UPPER STIRRUP XVC204/304/5	1.000	PC
Code	Description	Qty	UOM										
VM1166A0	CAP FOR DOOR UPPER STIRRUP XVC204/304/5	1.000	PC										

COMPONENT			SPARE PART																						
Code	Description	Image	Code	Description	Kit components																				
VM1190A	CT BT RIGHT DOOR SPRING LATCH		KVM1190A	CHEFTOP/BAKERTO P DOOR RIGHT LATCH KIT	<table border="1"> <thead> <tr> <th>Code</th> <th>Description</th> <th>Qty</th> <th>UOM</th> </tr> </thead> <tbody> <tr> <td>VI0239A1</td> <td>SELF-TAPPIN G SCREW 4.2X25 TCB+ INOX</td> <td>2.000</td> <td>PC</td> </tr> <tr> <td>VI1220A1</td> <td>4,2x12 TCB SELF-TAPPIN G SCREW</td> <td>2.000</td> <td>PC</td> </tr> <tr> <td>VM1460A0</td> <td>XBC/XVC RIGHT DOOR LATCH CAP</td> <td>1.000</td> <td>PC</td> </tr> <tr> <td>VP1530A0</td> <td></td> <td>1.000</td> <td>PC</td> </tr> </tbody> </table>	Code	Description	Qty	UOM	VI0239A1	SELF-TAPPIN G SCREW 4.2X25 TCB+ INOX	2.000	PC	VI1220A1	4,2x12 TCB SELF-TAPPIN G SCREW	2.000	PC	VM1460A0	XBC/XVC RIGHT DOOR LATCH CAP	1.000	PC	VP1530A0		1.000	PC
					Code	Description	Qty	UOM																	
					VI0239A1	SELF-TAPPIN G SCREW 4.2X25 TCB+ INOX	2.000	PC																	
					VI1220A1	4,2x12 TCB SELF-TAPPIN G SCREW	2.000	PC																	
VM1460A0	XBC/XVC RIGHT DOOR LATCH CAP	1.000	PC																						
VP1530A0		1.000	PC																						
<table border="1"> <thead> <tr> <th>Code</th> <th>Description</th> <th>Qty</th> <th>UOM</th> </tr> </thead> <tbody> <tr> <td>VI0239A1</td> <td>SELF-TAPPIN G SCREW 4.2X25 TCB+ INOX</td> <td>2.000</td> <td>PC</td> </tr> <tr> <td>VI1220A1</td> <td>4,2x12 TCB SELF-TAPPIN G SCREW</td> <td>2.000</td> <td>PC</td> </tr> <tr> <td>VM1460A0</td> <td>XBC/XVC RIGHT DOOR LATCH CAP</td> <td>1.000</td> <td>PC</td> </tr> <tr> <td>VP1531A0</td> <td></td> <td>1.000</td> <td>PC</td> </tr> </tbody> </table>	Code	Description	Qty	UOM	VI0239A1	SELF-TAPPIN G SCREW 4.2X25 TCB+ INOX	2.000	PC	VI1220A1	4,2x12 TCB SELF-TAPPIN G SCREW	2.000	PC	VM1460A0	XBC/XVC RIGHT DOOR LATCH CAP	1.000	PC	VP1531A0		1.000	PC					
Code	Description	Qty	UOM																						
VI0239A1	SELF-TAPPIN G SCREW 4.2X25 TCB+ INOX	2.000	PC																						
VI1220A1	4,2x12 TCB SELF-TAPPIN G SCREW	2.000	PC																						
VM1460A0	XBC/XVC RIGHT DOOR LATCH CAP	1.000	PC																						
VP1531A0		1.000	PC																						
<table border="1"> <thead> <tr> <th>Code</th> <th>Description</th> <th>Qty</th> <th>UOM</th> </tr> </thead> <tbody> <tr> <td>VI0239A1</td> <td>SELF-TAPPIN G SCREW 4.2X25 TCB+ INOX</td> <td>2.000</td> <td>PC</td> </tr> <tr> <td>VI1220A1</td> <td>4,2x12 TCB SELF-TAPPIN G SCREW</td> <td>2.000</td> <td>PC</td> </tr> <tr> <td>VM1460A0</td> <td>XBC/XVC RIGHT DOOR LATCH CAP</td> <td>1.000</td> <td>PC</td> </tr> <tr> <td>VP1531A0</td> <td></td> <td>1.000</td> <td>PC</td> </tr> </tbody> </table>	Code	Description	Qty	UOM	VI0239A1	SELF-TAPPIN G SCREW 4.2X25 TCB+ INOX	2.000	PC	VI1220A1	4,2x12 TCB SELF-TAPPIN G SCREW	2.000	PC	VM1460A0	XBC/XVC RIGHT DOOR LATCH CAP	1.000	PC	VP1531A0		1.000	PC					
Code	Description	Qty	UOM																						
VI0239A1	SELF-TAPPIN G SCREW 4.2X25 TCB+ INOX	2.000	PC																						
VI1220A1	4,2x12 TCB SELF-TAPPIN G SCREW	2.000	PC																						
VM1460A0	XBC/XVC RIGHT DOOR LATCH CAP	1.000	PC																						
VP1531A0		1.000	PC																						
<table border="1"> <thead> <tr> <th>Code</th> <th>Description</th> <th>Qty</th> <th>UOM</th> </tr> </thead> <tbody> <tr> <td>VI0239A1</td> <td>SELF-TAPPIN G SCREW 4.2X25 TCB+ INOX</td> <td>2.000</td> <td>PC</td> </tr> <tr> <td>VI1220A1</td> <td>4,2x12 TCB SELF-TAPPIN G SCREW</td> <td>2.000</td> <td>PC</td> </tr> <tr> <td>VM1460A0</td> <td>XBC/XVC RIGHT DOOR LATCH CAP</td> <td>1.000</td> <td>PC</td> </tr> <tr> <td>VP1531A0</td> <td></td> <td>1.000</td> <td>PC</td> </tr> </tbody> </table>	Code	Description	Qty	UOM	VI0239A1	SELF-TAPPIN G SCREW 4.2X25 TCB+ INOX	2.000	PC	VI1220A1	4,2x12 TCB SELF-TAPPIN G SCREW	2.000	PC	VM1460A0	XBC/XVC RIGHT DOOR LATCH CAP	1.000	PC	VP1531A0		1.000	PC					
Code	Description	Qty	UOM																						
VI0239A1	SELF-TAPPIN G SCREW 4.2X25 TCB+ INOX	2.000	PC																						
VI1220A1	4,2x12 TCB SELF-TAPPIN G SCREW	2.000	PC																						
VM1460A0	XBC/XVC RIGHT DOOR LATCH CAP	1.000	PC																						
VP1531A0		1.000	PC																						
VM1191A	CT BT LEFT DOOR SPRING LATCH		KVM1191A	CHEFTOP/BAKERTO P DOOR LEFT LATCH KIT	<table border="1"> <thead> <tr> <th>Code</th> <th>Description</th> <th>Qty</th> <th>UOM</th> </tr> </thead> <tbody> <tr> <td>VI0239A1</td> <td>SELF-TAPPIN G SCREW 4.2X25 TCB+ INOX</td> <td>2.000</td> <td>PC</td> </tr> <tr> <td>VI1220A1</td> <td>4,2x12 TCB SELF-TAPPIN G SCREW</td> <td>2.000</td> <td>PC</td> </tr> <tr> <td>VM1460A0</td> <td>XBC/XVC RIGHT DOOR LATCH CAP</td> <td>1.000</td> <td>PC</td> </tr> <tr> <td>VP1531A0</td> <td></td> <td>1.000</td> <td>PC</td> </tr> </tbody> </table>	Code	Description	Qty	UOM	VI0239A1	SELF-TAPPIN G SCREW 4.2X25 TCB+ INOX	2.000	PC	VI1220A1	4,2x12 TCB SELF-TAPPIN G SCREW	2.000	PC	VM1460A0	XBC/XVC RIGHT DOOR LATCH CAP	1.000	PC	VP1531A0		1.000	PC
					Code	Description	Qty	UOM																	
					VI0239A1	SELF-TAPPIN G SCREW 4.2X25 TCB+ INOX	2.000	PC																	
					VI1220A1	4,2x12 TCB SELF-TAPPIN G SCREW	2.000	PC																	
VM1460A0	XBC/XVC RIGHT DOOR LATCH CAP	1.000	PC																						
VP1531A0		1.000	PC																						
<table border="1"> <thead> <tr> <th>Code</th> <th>Description</th> <th>Qty</th> <th>UOM</th> </tr> </thead> <tbody> <tr> <td>VI0239A1</td> <td>SELF-TAPPIN G SCREW 4.2X25 TCB+ INOX</td> <td>2.000</td> <td>PC</td> </tr> <tr> <td>VI1220A1</td> <td>4,2x12 TCB SELF-TAPPIN G SCREW</td> <td>2.000</td> <td>PC</td> </tr> <tr> <td>VM1460A0</td> <td>XBC/XVC RIGHT DOOR LATCH CAP</td> <td>1.000</td> <td>PC</td> </tr> <tr> <td>VP1531A0</td> <td></td> <td>1.000</td> <td>PC</td> </tr> </tbody> </table>	Code	Description	Qty	UOM	VI0239A1	SELF-TAPPIN G SCREW 4.2X25 TCB+ INOX	2.000	PC	VI1220A1	4,2x12 TCB SELF-TAPPIN G SCREW	2.000	PC	VM1460A0	XBC/XVC RIGHT DOOR LATCH CAP	1.000	PC	VP1531A0		1.000	PC					
Code	Description	Qty	UOM																						
VI0239A1	SELF-TAPPIN G SCREW 4.2X25 TCB+ INOX	2.000	PC																						
VI1220A1	4,2x12 TCB SELF-TAPPIN G SCREW	2.000	PC																						
VM1460A0	XBC/XVC RIGHT DOOR LATCH CAP	1.000	PC																						
VP1531A0		1.000	PC																						
<table border="1"> <thead> <tr> <th>Code</th> <th>Description</th> <th>Qty</th> <th>UOM</th> </tr> </thead> <tbody> <tr> <td>VI0239A1</td> <td>SELF-TAPPIN G SCREW 4.2X25 TCB+ INOX</td> <td>2.000</td> <td>PC</td> </tr> <tr> <td>VI1220A1</td> <td>4,2x12 TCB SELF-TAPPIN G SCREW</td> <td>2.000</td> <td>PC</td> </tr> <tr> <td>VM1460A0</td> <td>XBC/XVC RIGHT DOOR LATCH CAP</td> <td>1.000</td> <td>PC</td> </tr> <tr> <td>VP1531A0</td> <td></td> <td>1.000</td> <td>PC</td> </tr> </tbody> </table>	Code	Description	Qty	UOM	VI0239A1	SELF-TAPPIN G SCREW 4.2X25 TCB+ INOX	2.000	PC	VI1220A1	4,2x12 TCB SELF-TAPPIN G SCREW	2.000	PC	VM1460A0	XBC/XVC RIGHT DOOR LATCH CAP	1.000	PC	VP1531A0		1.000	PC					
Code	Description	Qty	UOM																						
VI0239A1	SELF-TAPPIN G SCREW 4.2X25 TCB+ INOX	2.000	PC																						
VI1220A1	4,2x12 TCB SELF-TAPPIN G SCREW	2.000	PC																						
VM1460A0	XBC/XVC RIGHT DOOR LATCH CAP	1.000	PC																						
VP1531A0		1.000	PC																						
<table border="1"> <thead> <tr> <th>Code</th> <th>Description</th> <th>Qty</th> <th>UOM</th> </tr> </thead> <tbody> <tr> <td>VI0239A1</td> <td>SELF-TAPPIN G SCREW 4.2X25 TCB+ INOX</td> <td>2.000</td> <td>PC</td> </tr> <tr> <td>VI1220A1</td> <td>4,2x12 TCB SELF-TAPPIN G SCREW</td> <td>2.000</td> <td>PC</td> </tr> <tr> <td>VM1460A0</td> <td>XBC/XVC RIGHT DOOR LATCH CAP</td> <td>1.000</td> <td>PC</td> </tr> <tr> <td>VP1531A0</td> <td></td> <td>1.000</td> <td>PC</td> </tr> </tbody> </table>	Code	Description	Qty	UOM	VI0239A1	SELF-TAPPIN G SCREW 4.2X25 TCB+ INOX	2.000	PC	VI1220A1	4,2x12 TCB SELF-TAPPIN G SCREW	2.000	PC	VM1460A0	XBC/XVC RIGHT DOOR LATCH CAP	1.000	PC	VP1531A0		1.000	PC					
Code	Description	Qty	UOM																						
VI0239A1	SELF-TAPPIN G SCREW 4.2X25 TCB+ INOX	2.000	PC																						
VI1220A1	4,2x12 TCB SELF-TAPPIN G SCREW	2.000	PC																						
VM1460A0	XBC/XVC RIGHT DOOR LATCH CAP	1.000	PC																						
VP1531A0		1.000	PC																						
VM1192A	CT BT DOOR SPRING LATCH BACK COVER		KVM1191A	CHEFTOP/BAKERTO P DOOR LEFT LATCH KIT	<table border="1"> <thead> <tr> <th>Code</th> <th>Description</th> <th>Qty</th> <th>UOM</th> </tr> </thead> <tbody> <tr> <td>VI0239A1</td> <td>SELF-TAPPIN G SCREW 4.2X25 TCB+ INOX</td> <td>2.000</td> <td>PC</td> </tr> <tr> <td>VI1220A1</td> <td>4,2x12 TCB SELF-TAPPIN G SCREW</td> <td>2.000</td> <td>PC</td> </tr> <tr> <td>VM1460A0</td> <td>XBC/XVC RIGHT DOOR LATCH CAP</td> <td>1.000</td> <td>PC</td> </tr> <tr> <td>VP1531A0</td> <td></td> <td>1.000</td> <td>PC</td> </tr> </tbody> </table>	Code	Description	Qty	UOM	VI0239A1	SELF-TAPPIN G SCREW 4.2X25 TCB+ INOX	2.000	PC	VI1220A1	4,2x12 TCB SELF-TAPPIN G SCREW	2.000	PC	VM1460A0	XBC/XVC RIGHT DOOR LATCH CAP	1.000	PC	VP1531A0		1.000	PC
			Code	Description	Qty	UOM																			
			VI0239A1	SELF-TAPPIN G SCREW 4.2X25 TCB+ INOX	2.000	PC																			
			VI1220A1	4,2x12 TCB SELF-TAPPIN G SCREW	2.000	PC																			
VM1460A0	XBC/XVC RIGHT DOOR LATCH CAP	1.000	PC																						
VP1531A0		1.000	PC																						
KVM1190A	CHEFTOP/BAKERTO P DOOR RIGHT LATCH KIT	<table border="1"> <thead> <tr> <th>Code</th> <th>Description</th> <th>Qty</th> <th>UOM</th> </tr> </thead> <tbody> <tr> <td>VI0239A1</td> <td>SELF-TAPPIN G SCREW 4.2X25 TCB+ INOX</td> <td>2.000</td> <td>PC</td> </tr> <tr> <td>VI1220A1</td> <td>4,2x12 TCB SELF-TAPPIN G SCREW</td> <td>2.000</td> <td>PC</td> </tr> <tr> <td>VM1460A0</td> <td>XBC/XVC RIGHT DOOR LATCH CAP</td> <td>1.000</td> <td>PC</td> </tr> <tr> <td>VP1530A0</td> <td></td> <td>1.000</td> <td>PC</td> </tr> </tbody> </table>	Code	Description	Qty	UOM	VI0239A1	SELF-TAPPIN G SCREW 4.2X25 TCB+ INOX	2.000	PC	VI1220A1	4,2x12 TCB SELF-TAPPIN G SCREW	2.000	PC	VM1460A0	XBC/XVC RIGHT DOOR LATCH CAP	1.000	PC	VP1530A0		1.000	PC			
Code	Description	Qty	UOM																						
VI0239A1	SELF-TAPPIN G SCREW 4.2X25 TCB+ INOX	2.000	PC																						
VI1220A1	4,2x12 TCB SELF-TAPPIN G SCREW	2.000	PC																						
VM1460A0	XBC/XVC RIGHT DOOR LATCH CAP	1.000	PC																						
VP1530A0		1.000	PC																						
<table border="1"> <thead> <tr> <th>Code</th> <th>Description</th> <th>Qty</th> <th>UOM</th> </tr> </thead> <tbody> <tr> <td>VI0239A1</td> <td>SELF-TAPPIN G SCREW 4.2X25 TCB+ INOX</td> <td>2.000</td> <td>PC</td> </tr> <tr> <td>VI1220A1</td> <td>4,2x12 TCB SELF-TAPPIN G SCREW</td> <td>2.000</td> <td>PC</td> </tr> <tr> <td>VM1460A0</td> <td>XBC/XVC RIGHT DOOR LATCH CAP</td> <td>1.000</td> <td>PC</td> </tr> <tr> <td>VP1531A0</td> <td></td> <td>1.000</td> <td>PC</td> </tr> </tbody> </table>	Code	Description	Qty	UOM	VI0239A1	SELF-TAPPIN G SCREW 4.2X25 TCB+ INOX	2.000	PC	VI1220A1	4,2x12 TCB SELF-TAPPIN G SCREW	2.000	PC	VM1460A0	XBC/XVC RIGHT DOOR LATCH CAP	1.000	PC	VP1531A0		1.000	PC					
Code	Description	Qty	UOM																						
VI0239A1	SELF-TAPPIN G SCREW 4.2X25 TCB+ INOX	2.000	PC																						
VI1220A1	4,2x12 TCB SELF-TAPPIN G SCREW	2.000	PC																						
VM1460A0	XBC/XVC RIGHT DOOR LATCH CAP	1.000	PC																						
VP1531A0		1.000	PC																						
<table border="1"> <thead> <tr> <th>Code</th> <th>Description</th> <th>Qty</th> <th>UOM</th> </tr> </thead> <tbody> <tr> <td>VI0239A1</td> <td>SELF-TAPPIN G SCREW 4.2X25 TCB+ INOX</td> <td>2.000</td> <td>PC</td> </tr> <tr> <td>VI1220A1</td> <td>4,2x12 TCB SELF-TAPPIN G SCREW</td> <td>2.000</td> <td>PC</td> </tr> <tr> <td>VM1460A0</td> <td>XBC/XVC RIGHT DOOR LATCH CAP</td> <td>1.000</td> <td>PC</td> </tr> <tr> <td>VP1531A0</td> <td></td> <td>1.000</td> <td>PC</td> </tr> </tbody> </table>	Code	Description	Qty	UOM	VI0239A1	SELF-TAPPIN G SCREW 4.2X25 TCB+ INOX	2.000	PC	VI1220A1	4,2x12 TCB SELF-TAPPIN G SCREW	2.000	PC	VM1460A0	XBC/XVC RIGHT DOOR LATCH CAP	1.000	PC	VP1531A0		1.000	PC					
Code	Description	Qty	UOM																						
VI0239A1	SELF-TAPPIN G SCREW 4.2X25 TCB+ INOX	2.000	PC																						
VI1220A1	4,2x12 TCB SELF-TAPPIN G SCREW	2.000	PC																						
VM1460A0	XBC/XVC RIGHT DOOR LATCH CAP	1.000	PC																						
VP1531A0		1.000	PC																						



COMPONENT			SPARE PART																						
Code	Description	Image	Code	Description	Kit components																				
VM1195A	HOLES BLANKING PLATE XVC204/304/504/704		VM1195A0	HOLES BLANKING PLATE XVC204/304/504/704																					
VM1240A	NYLON SUPPORT CAP		KVM1240A	4 PCS COUNTER BRACKET SUPPORT CAP KIT	<table border="1"> <thead> <tr> <th>Code</th> <th>Description</th> <th>Qty</th> <th>UOM</th> </tr> </thead> <tbody> <tr> <td>VM1240A0</td> <td>NYLON SUPPORT CAP</td> <td>4.000</td> <td>PC</td> </tr> </tbody> </table>	Code	Description	Qty	UOM	VM1240A0	NYLON SUPPORT CAP	4.000	PC												
Code	Description	Qty	UOM																						
VM1240A0	NYLON SUPPORT CAP	4.000	PC																						
VM1460A	XBC/XVC RIGHT DOOR LATCH CAP		KVM1460A	XBC/XVC RIGHT DOOR LATCH CAP KIT	<table border="1"> <thead> <tr> <th>Code</th> <th>Description</th> <th>Qty</th> <th>UOM</th> </tr> </thead> <tbody> <tr> <td>VI0239A1</td> <td>SELF-TAPPIN G SCREW 4.2X25 TCB+ INOX</td> <td>2.000</td> <td>PC</td> </tr> <tr> <td>VM1460A0</td> <td>XBC/XVC RIGHT DOOR LATCH CAP</td> <td>1.000</td> <td>PC</td> </tr> </tbody> </table>	Code	Description	Qty	UOM	VI0239A1	SELF-TAPPIN G SCREW 4.2X25 TCB+ INOX	2.000	PC	VM1460A0	XBC/XVC RIGHT DOOR LATCH CAP	1.000	PC								
Code	Description	Qty	UOM																						
VI0239A1	SELF-TAPPIN G SCREW 4.2X25 TCB+ INOX	2.000	PC																						
VM1460A0	XBC/XVC RIGHT DOOR LATCH CAP	1.000	PC																						
VM1461A	XBC/XVC LEFT DOOR LATCH COVE		KVM1461A	XBC/XVC LEFT DOOR LATCH COVER KIT	<table border="1"> <thead> <tr> <th>Code</th> <th>Description</th> <th>Qty</th> <th>UOM</th> </tr> </thead> <tbody> <tr> <td>VI0239A1</td> <td>SELF-TAPPIN G SCREW 4.2X25 TCB+ INOX</td> <td>2.000</td> <td>PC</td> </tr> <tr> <td>VM1461A0</td> <td>XBC/XVC LEFT DOOR LATCH COVER</td> <td>1.000</td> <td>PC</td> </tr> </tbody> </table>	Code	Description	Qty	UOM	VI0239A1	SELF-TAPPIN G SCREW 4.2X25 TCB+ INOX	2.000	PC	VM1461A0	XBC/XVC LEFT DOOR LATCH COVER	1.000	PC								
Code	Description	Qty	UOM																						
VI0239A1	SELF-TAPPIN G SCREW 4.2X25 TCB+ INOX	2.000	PC																						
VM1461A0	XBC/XVC LEFT DOOR LATCH COVER	1.000	PC																						
VM1505A	WALL PASSING WITH DIAPHRAGM		KVM1505A	THROUGH-WALL CONNECTION+DIAPHRAGM KIT	<table border="1"> <thead> <tr> <th>Code</th> <th>Description</th> <th>Qty</th> <th>UOM</th> </tr> </thead> <tbody> <tr> <td>VI1220A1</td> <td>4,2X12 TCB SELF-TAPPIN G SCREW</td> <td>1.000</td> <td>PC</td> </tr> <tr> <td>VM1505A0</td> <td>WALL PASSING WITH DIAPHRAGM</td> <td>3.000</td> <td>PC</td> </tr> <tr> <td>VM2055A0</td> <td>UPPER WALL PASSING ACCESSORY CABLES</td> <td>1.000</td> <td>PC</td> </tr> <tr> <td>VM2056A0</td> <td>LOWER WALL PASSING ACCESSORY CABLES</td> <td>1.000</td> <td>PC</td> </tr> </tbody> </table>	Code	Description	Qty	UOM	VI1220A1	4,2X12 TCB SELF-TAPPIN G SCREW	1.000	PC	VM1505A0	WALL PASSING WITH DIAPHRAGM	3.000	PC	VM2055A0	UPPER WALL PASSING ACCESSORY CABLES	1.000	PC	VM2056A0	LOWER WALL PASSING ACCESSORY CABLES	1.000	PC
Code	Description	Qty	UOM																						
VI1220A1	4,2X12 TCB SELF-TAPPIN G SCREW	1.000	PC																						
VM1505A0	WALL PASSING WITH DIAPHRAGM	3.000	PC																						
VM2055A0	UPPER WALL PASSING ACCESSORY CABLES	1.000	PC																						
VM2056A0	LOWER WALL PASSING ACCESSORY CABLES	1.000	PC																						



COMPONENT			SPARE PART										
Code	Description	Image	Code	Description	Kit components								
VM1974A	CONTROL PANEL CLOSING PLATE		VM1974A0	CONTROL PANEL CLOSING PLATE									
VM1975A	DOOR SUPPORT LOWER BRACKET		VM1975A0	DOOR SUPPORT LOWER BRACKET									
VM2028A	20x10x4 RUBBER WASHER		KVM2028A	20x10x4 RUBBER WASHER 5 PCS. KIT	<table border="1"> <thead> <tr> <th>Code</th> <th>Description</th> <th>Qty</th> <th>UOM</th> </tr> </thead> <tbody> <tr> <td>VM2028A0</td> <td>20x10x4 RUBBER WASHER</td> <td>5.000</td> <td>PC</td> </tr> </tbody> </table>	Code	Description	Qty	UOM	VM2028A0	20x10x4 RUBBER WASHER	5.000	PC
Code	Description	Qty	UOM										
VM2028A0	20x10x4 RUBBER WASHER	5.000	PC										
VM2035A	DRAIN PIPE SUPPORT		KVM2035A	DRAIN PIPE SUPPORT 2 PCS. KI	<table border="1"> <thead> <tr> <th>Code</th> <th>Description</th> <th>Qty</th> <th>UOM</th> </tr> </thead> <tbody> <tr> <td>VM2035A0</td> <td>DRAIN PIPE SUPPORT</td> <td>2.000</td> <td>PC</td> </tr> </tbody> </table>	Code	Description	Qty	UOM	VM2035A0	DRAIN PIPE SUPPORT	2.000	PC
Code	Description	Qty	UOM										
VM2035A0	DRAIN PIPE SUPPORT	2.000	PC										



ASM2793A/0.D00 - General overview

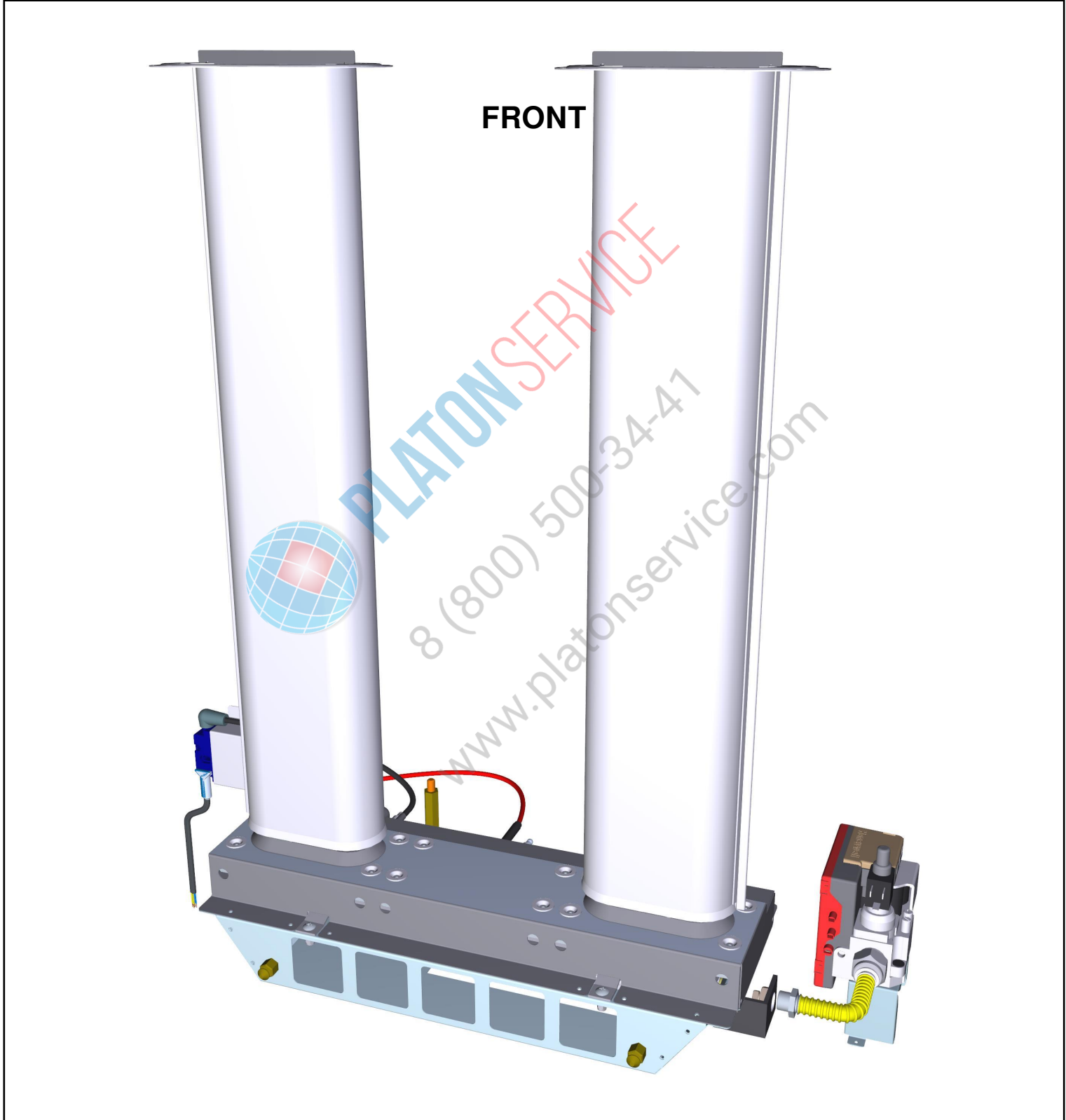





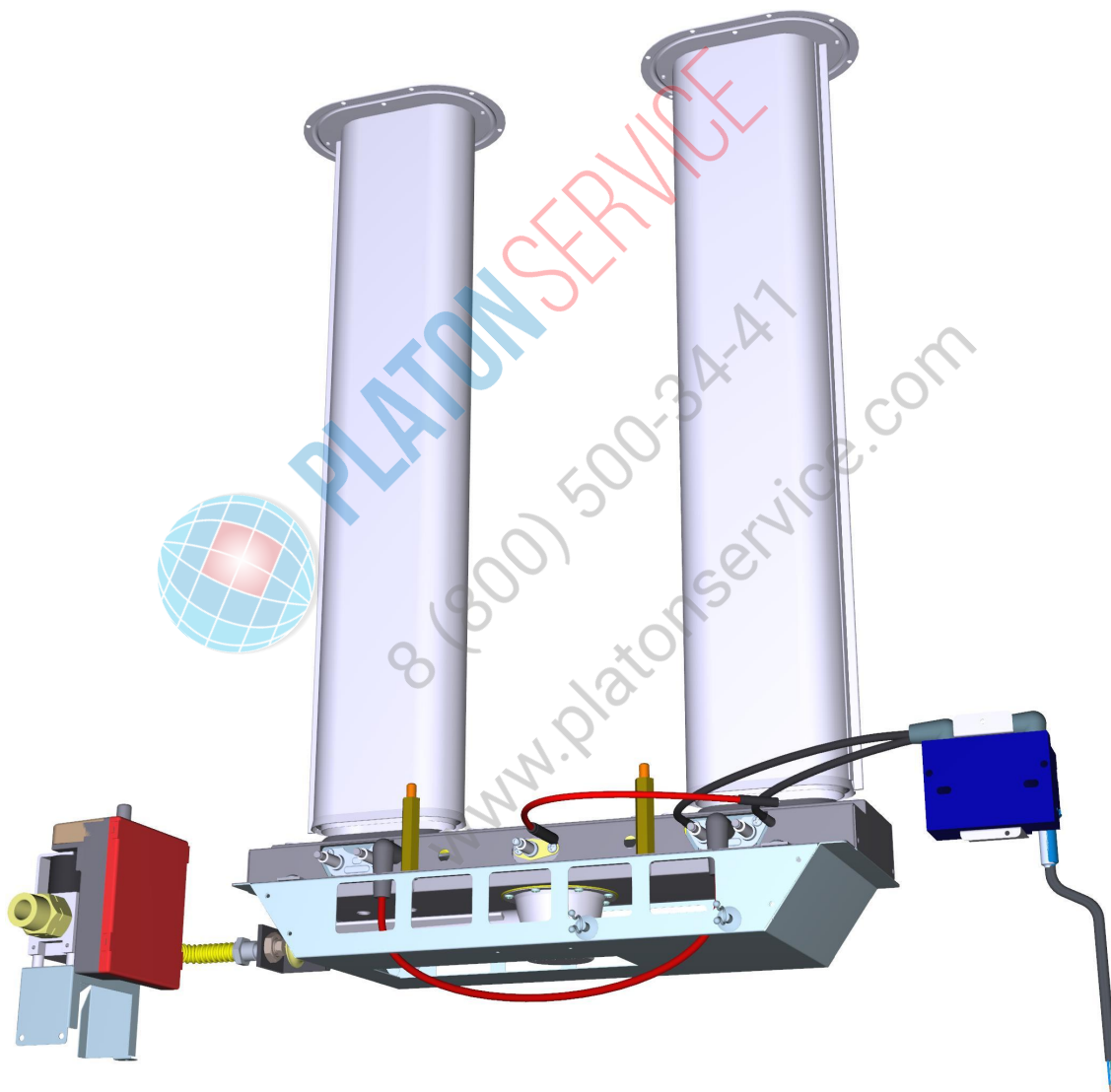

ASM2793A/0.D00 - General overview

REAR





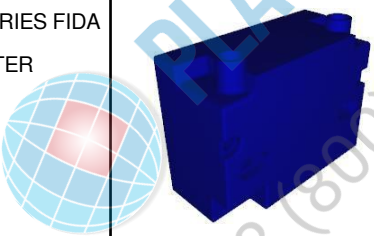

COMPONENT			SPARE PART																																						
Code	Description	Image	Code	Description	Kit components																																				
0N1135A	GAS BAFFLE FORK		0N1135A2	GAS BAFFLE FORK																																					
0H5126A	IGNITER FIXING OMEGA		0H5126A0	IGNITER FIXING OMEGA																																					
CE1777A	HV START UP CABLE L=700 WITH SILICON CAP		KVE0013A	AUSTRALIAN VERSION GAS IGNITER KIT	<table border="1"> <thead> <tr> <th>Code</th> <th>Description</th> <th>Qty</th> <th>UOM</th> </tr> </thead> <tbody> <tr> <td>0H5126A0</td> <td>IGNITER FIXING OMEGA</td> <td>1.000</td> <td>PC</td> </tr> <tr> <td>CE1777A1</td> <td>HV START UP CABLE L=700 WITH SILICON CAP</td> <td>2.000</td> <td>PC</td> </tr> <tr> <td>CE1782A0</td> <td>HV L=300 BRIDGE FIDA CABLE</td> <td>1.000</td> <td>PC</td> </tr> <tr> <td>CE1789A0</td> <td>LIGHTER POWER SUPPLY FIDA CABLE</td> <td>1.000</td> <td>PC</td> </tr> <tr> <td>CE1792A0</td> <td>FLAME DETECTOR CANDLE CABL</td> <td>1.000</td> <td>PC</td> </tr> <tr> <td>GN1328A1</td> <td>BACK BLACK ADESIVE GASKET 8X3</td> <td>0.500</td> <td>M</td> </tr> <tr> <td>VE1621A0</td> <td>FIDA LIGHTER</td> <td>1.000</td> <td>PC</td> </tr> <tr> <td>VI1220A1</td> <td>4,2x12 TCB SELF-TAPPIN G SCREW</td> <td>2.000</td> <td>PC</td> </tr> </tbody> </table>	Code	Description	Qty	UOM	0H5126A0	IGNITER FIXING OMEGA	1.000	PC	CE1777A1	HV START UP CABLE L=700 WITH SILICON CAP	2.000	PC	CE1782A0	HV L=300 BRIDGE FIDA CABLE	1.000	PC	CE1789A0	LIGHTER POWER SUPPLY FIDA CABLE	1.000	PC	CE1792A0	FLAME DETECTOR CANDLE CABL	1.000	PC	GN1328A1	BACK BLACK ADESIVE GASKET 8X3	0.500	M	VE1621A0	FIDA LIGHTER	1.000	PC	VI1220A1	4,2x12 TCB SELF-TAPPIN G SCREW	2.000	PC
Code	Description	Qty	UOM																																						
0H5126A0	IGNITER FIXING OMEGA	1.000	PC																																						
CE1777A1	HV START UP CABLE L=700 WITH SILICON CAP	2.000	PC																																						
CE1782A0	HV L=300 BRIDGE FIDA CABLE	1.000	PC																																						
CE1789A0	LIGHTER POWER SUPPLY FIDA CABLE	1.000	PC																																						
CE1792A0	FLAME DETECTOR CANDLE CABL	1.000	PC																																						
GN1328A1	BACK BLACK ADESIVE GASKET 8X3	0.500	M																																						
VE1621A0	FIDA LIGHTER	1.000	PC																																						
VI1220A1	4,2x12 TCB SELF-TAPPIN G SCREW	2.000	PC																																						
			KVE0010A	USA VERSION GAS IGNITER KIT	<table border="1"> <thead> <tr> <th>Code</th> <th>Description</th> <th>Qty</th> <th>UOM</th> </tr> </thead> <tbody> <tr> <td>0H7457A1</td> <td>VE1637A IGNITION BOX HOLDING PLATE</td> <td>1.000</td> <td>PC</td> </tr> <tr> <td>CE1056A0</td> <td>IC POWER CABLE UNIT GAS USA MM</td> <td>2.000</td> <td>PC</td> </tr> </tbody> </table>	Code	Description	Qty	UOM	0H7457A1	VE1637A IGNITION BOX HOLDING PLATE	1.000	PC	CE1056A0	IC POWER CABLE UNIT GAS USA MM	2.000	PC																								
Code	Description	Qty	UOM																																						
0H7457A1	VE1637A IGNITION BOX HOLDING PLATE	1.000	PC																																						
CE1056A0	IC POWER CABLE UNIT GAS USA MM	2.000	PC																																						

COMPONENT			SPARE PART																																															
Code	Description	Image	Code	Description	Kit components																																													
CE1777A	HV START UP CABLE L=700 WITH SILICON CAP		KVE0010A	USA VERSION GAS IGNITER KIT	<table border="1"> <thead> <tr> <th>Code</th> <th>Description</th> <th>Qty</th> <th>UOM</th> </tr> </thead> <tbody> <tr> <td>CE1057B0</td> <td>MM USA GAS-IGNITER CONTROL EV CABLE</td> <td>2.000</td> <td>PC</td> </tr> <tr> <td>CE1059A1</td> <td>3P-6.35MM FLAME DETECTOR 10KV CABLE</td> <td>2.000</td> <td>PC</td> </tr> <tr> <td>CE1777A1</td> <td>HV START UP CABLE L=700 WITH SILICON CAP</td> <td>4.000</td> <td>PC</td> </tr> <tr> <td>GN1328A1</td> <td>BACK BLACK ADESIVE GASKET 8X3</td> <td>0.500</td> <td>M</td> </tr> <tr> <td>VE1637A0</td> <td>FLAME CONTROL BOARD</td> <td>2.000</td> <td>PC</td> </tr> <tr> <td>VI1220A1</td> <td>4,2x12 TCB SELF-TAPPIN G SCREW</td> <td>4.000</td> <td>PC</td> </tr> </tbody> </table>	Code	Description	Qty	UOM	CE1057B0	MM USA GAS-IGNITER CONTROL EV CABLE	2.000	PC	CE1059A1	3P-6.35MM FLAME DETECTOR 10KV CABLE	2.000	PC	CE1777A1	HV START UP CABLE L=700 WITH SILICON CAP	4.000	PC	GN1328A1	BACK BLACK ADESIVE GASKET 8X3	0.500	M	VE1637A0	FLAME CONTROL BOARD	2.000	PC	VI1220A1	4,2x12 TCB SELF-TAPPIN G SCREW	4.000	PC																	
			Code	Description	Qty	UOM																																												
CE1057B0	MM USA GAS-IGNITER CONTROL EV CABLE	2.000	PC																																															
CE1059A1	3P-6.35MM FLAME DETECTOR 10KV CABLE	2.000	PC																																															
CE1777A1	HV START UP CABLE L=700 WITH SILICON CAP	4.000	PC																																															
GN1328A1	BACK BLACK ADESIVE GASKET 8X3	0.500	M																																															
VE1637A0	FLAME CONTROL BOARD	2.000	PC																																															
VI1220A1	4,2x12 TCB SELF-TAPPIN G SCREW	4.000	PC																																															
KVE0009B	EUROPE VERSION GAS IGNITER KIT	<table border="1"> <thead> <tr> <th>Code</th> <th>Description</th> <th>Qty</th> <th>UOM</th> </tr> </thead> <tbody> <tr> <td>0H5126A0</td> <td>IGNITER FIXING OMEG</td> <td>1.000</td> <td>PC</td> </tr> <tr> <td>0H6825A0</td> <td>METAL CLAMP</td> <td>1.000</td> <td>PC</td> </tr> <tr> <td>CE1390A0</td> <td>YELLOW CABLE UNIP RUBB.SIL. Ø 0,75 MMQ</td> <td>0.260</td> <td>M</td> </tr> <tr> <td>CE1395A0</td> <td>6,3 X 0,8 MALE FASTO</td> <td>4.000</td> <td>PC</td> </tr> <tr> <td>CE1661A0</td> <td>MALE FASTON COVER 6,3x0,8</td> <td>4.000</td> <td>PC</td> </tr> <tr> <td>CE1777A1</td> <td>HV START UP CABLE L=700 WITH SILICON CAP</td> <td>2.000</td> <td>PC</td> </tr> <tr> <td>CE1782A0</td> <td>HV L=300 BRIDGE FIDA CABLE</td> <td>1.000</td> <td>PC</td> </tr> <tr> <td>CE1792A0</td> <td>FLAME DETECTOR CANDLE CABL</td> <td>1.000</td> <td>PC</td> </tr> <tr> <td>CE1811A1</td> <td>LIGHTER CONNECTING CABLE PLUG 90°</td> <td>1.000</td> <td>PC</td> </tr> <tr> <td>GN1328A1</td> <td>BACK BLACK ADESIVE GASKET 8X3</td> <td>0.500</td> <td>M</td> </tr> <tr> <td>VE1625A0</td> <td>5E- MM SERIES FIDA GAS LIGHTER</td> <td>1.000</td> <td>PC</td> </tr> </tbody> </table>	Code	Description	Qty	UOM	0H5126A0	IGNITER FIXING OMEG	1.000	PC	0H6825A0	METAL CLAMP	1.000	PC	CE1390A0	YELLOW CABLE UNIP RUBB.SIL. Ø 0,75 MMQ	0.260	M	CE1395A0	6,3 X 0,8 MALE FASTO	4.000	PC	CE1661A0	MALE FASTON COVER 6,3x0,8	4.000	PC	CE1777A1	HV START UP CABLE L=700 WITH SILICON CAP	2.000	PC	CE1782A0	HV L=300 BRIDGE FIDA CABLE	1.000	PC	CE1792A0	FLAME DETECTOR CANDLE CABL	1.000	PC	CE1811A1	LIGHTER CONNECTING CABLE PLUG 90°	1.000	PC	GN1328A1	BACK BLACK ADESIVE GASKET 8X3	0.500	M	VE1625A0	5E- MM SERIES FIDA GAS LIGHTER	1.000	PC
Code	Description	Qty	UOM																																															
0H5126A0	IGNITER FIXING OMEG	1.000	PC																																															
0H6825A0	METAL CLAMP	1.000	PC																																															
CE1390A0	YELLOW CABLE UNIP RUBB.SIL. Ø 0,75 MMQ	0.260	M																																															
CE1395A0	6,3 X 0,8 MALE FASTO	4.000	PC																																															
CE1661A0	MALE FASTON COVER 6,3x0,8	4.000	PC																																															
CE1777A1	HV START UP CABLE L=700 WITH SILICON CAP	2.000	PC																																															
CE1782A0	HV L=300 BRIDGE FIDA CABLE	1.000	PC																																															
CE1792A0	FLAME DETECTOR CANDLE CABL	1.000	PC																																															
CE1811A1	LIGHTER CONNECTING CABLE PLUG 90°	1.000	PC																																															
GN1328A1	BACK BLACK ADESIVE GASKET 8X3	0.500	M																																															
VE1625A0	5E- MM SERIES FIDA GAS LIGHTER	1.000	PC																																															

COMPONENT			SPARE PART																																																						
Code	Description	Image	Code	Description	Kit components																																																				
CE1777A	HV START UP CABLE L=700 WITH SILICON CAP		KVE0009B	EUROPE VERSION GAS IGNITER KIT	<table border="1"> <thead> <tr> <th>Code</th> <th>Description</th> <th>Qty</th> <th>UOM</th> </tr> </thead> <tbody> <tr> <td>VI1220A1</td> <td>4,2x12 TCB SELF-TAPPIN G SCREW</td> <td>2.000</td> <td>PC</td> </tr> <tr> <td>VI1950A0</td> <td>ST. STEEL 4,2X13 TCB SELF-DRILLIN G SCREW</td> <td>1.000</td> <td>PC</td> </tr> <tr> <td>VM1255A1</td> <td>THREAD-COV ERING CAP MARUTEX</td> <td>1.000</td> <td>PC</td> </tr> </tbody> </table>	Code	Description	Qty	UOM	VI1220A1	4,2x12 TCB SELF-TAPPIN G SCREW	2.000	PC	VI1950A0	ST. STEEL 4,2X13 TCB SELF-DRILLIN G SCREW	1.000	PC	VM1255A1	THREAD-COV ERING CAP MARUTEX	1.000	PC																																				
			Code	Description	Qty	UOM																																																			
VI1220A1	4,2x12 TCB SELF-TAPPIN G SCREW	2.000	PC																																																						
VI1950A0	ST. STEEL 4,2X13 TCB SELF-DRILLIN G SCREW	1.000	PC																																																						
VM1255A1	THREAD-COV ERING CAP MARUTEX	1.000	PC																																																						
KCE1777A	EUROPE VERSION HV START UP CABLES KIT	<table border="1"> <thead> <tr> <th>Code</th> <th>Description</th> <th>Qty</th> <th>UOM</th> </tr> </thead> <tbody> <tr> <td>CE1777A1</td> <td>HV START UP CABLE L=700 WITH SILICON CAP</td> <td>2.000</td> <td>PC</td> </tr> <tr> <td>CE1782A0</td> <td>HV L=300 BRIDGE FIDA CABLE</td> <td>1.000</td> <td>PC</td> </tr> </tbody> </table>	Code	Description	Qty	UOM	CE1777A1	HV START UP CABLE L=700 WITH SILICON CAP	2.000	PC	CE1782A0	HV L=300 BRIDGE FIDA CABLE	1.000	PC																																											
Code	Description	Qty	UOM																																																						
CE1777A1	HV START UP CABLE L=700 WITH SILICON CAP	2.000	PC																																																						
CE1782A0	HV L=300 BRIDGE FIDA CABLE	1.000	PC																																																						
VE1625A	5E- MM SERIES FIDA GAS LIGHTER		KVE0009B	EUROPE VERSION GAS IGNITER KIT	<table border="1"> <thead> <tr> <th>Code</th> <th>Description</th> <th>Qty</th> <th>UOM</th> </tr> </thead> <tbody> <tr> <td>0H5126A0</td> <td>IGNITER FIXING OMEG</td> <td>1.000</td> <td>PC</td> </tr> <tr> <td>0H6825A0</td> <td>METAL CLAMP</td> <td>1.000</td> <td>PC</td> </tr> <tr> <td>CE1390A0</td> <td>YELLOW CABLE UNIP RUBB.SIL. Ø 0,75 MMQ</td> <td>0.260</td> <td>M</td> </tr> <tr> <td>CE1395A0</td> <td>6,3 X 0,8 iMALE FASTO</td> <td>4.000</td> <td>PC</td> </tr> <tr> <td>CE1661A0</td> <td>MALE FASTON COVER 6,3x0,8</td> <td>4.000</td> <td>PC</td> </tr> <tr> <td>CE1777A1</td> <td>HV START UP CABLE L=700 WITH SILICON CAP</td> <td>2.000</td> <td>PC</td> </tr> <tr> <td>CE1782A0</td> <td>HV L=300 BRIDGE FIDA CABLE</td> <td>1.000</td> <td>PC</td> </tr> <tr> <td>CE1792A0</td> <td>FLAME DETECTOR CANDLE CABL</td> <td>1.000</td> <td>PC</td> </tr> <tr> <td>CE1811A1</td> <td>LIGHTER CONNECTING CABLE PLUG 90°</td> <td>1.000</td> <td>PC</td> </tr> <tr> <td>GN1328A1</td> <td>BACK BLACK ADESIVE GASKET 8X3</td> <td>0.500</td> <td>M</td> </tr> <tr> <td>VE1625A0</td> <td>5E- MM SERIES FIDA GAS LIGHTER</td> <td>1.000</td> <td>PC</td> </tr> <tr> <td>VI1220A1</td> <td>4,2x12 TCB SELF-TAPPIN G SCREW</td> <td>2.000</td> <td>PC</td> </tr> </tbody> </table>	Code	Description	Qty	UOM	0H5126A0	IGNITER FIXING OMEG	1.000	PC	0H6825A0	METAL CLAMP	1.000	PC	CE1390A0	YELLOW CABLE UNIP RUBB.SIL. Ø 0,75 MMQ	0.260	M	CE1395A0	6,3 X 0,8 iMALE FASTO	4.000	PC	CE1661A0	MALE FASTON COVER 6,3x0,8	4.000	PC	CE1777A1	HV START UP CABLE L=700 WITH SILICON CAP	2.000	PC	CE1782A0	HV L=300 BRIDGE FIDA CABLE	1.000	PC	CE1792A0	FLAME DETECTOR CANDLE CABL	1.000	PC	CE1811A1	LIGHTER CONNECTING CABLE PLUG 90°	1.000	PC	GN1328A1	BACK BLACK ADESIVE GASKET 8X3	0.500	M	VE1625A0	5E- MM SERIES FIDA GAS LIGHTER	1.000	PC	VI1220A1	4,2x12 TCB SELF-TAPPIN G SCREW	2.000	PC
			Code	Description	Qty	UOM																																																			
			0H5126A0	IGNITER FIXING OMEG	1.000	PC																																																			
			0H6825A0	METAL CLAMP	1.000	PC																																																			
			CE1390A0	YELLOW CABLE UNIP RUBB.SIL. Ø 0,75 MMQ	0.260	M																																																			
			CE1395A0	6,3 X 0,8 iMALE FASTO	4.000	PC																																																			
			CE1661A0	MALE FASTON COVER 6,3x0,8	4.000	PC																																																			
			CE1777A1	HV START UP CABLE L=700 WITH SILICON CAP	2.000	PC																																																			
			CE1782A0	HV L=300 BRIDGE FIDA CABLE	1.000	PC																																																			
			CE1792A0	FLAME DETECTOR CANDLE CABL	1.000	PC																																																			
			CE1811A1	LIGHTER CONNECTING CABLE PLUG 90°	1.000	PC																																																			
			GN1328A1	BACK BLACK ADESIVE GASKET 8X3	0.500	M																																																			
			VE1625A0	5E- MM SERIES FIDA GAS LIGHTER	1.000	PC																																																			
VI1220A1	4,2x12 TCB SELF-TAPPIN G SCREW	2.000	PC																																																						

COMPONENT			SPARE PART																						
Code	Description	Image	Code	Description	Kit components																				
VE1625A	5E- MM SERIES FIDA GAS LIGHTER		KVE0009B	EUROPE VERSION GAS IGNITER KIT	<table border="1"> <thead> <tr> <th>Code</th> <th>Description</th> <th>Qty</th> <th>UOM</th> </tr> </thead> <tbody> <tr> <td>VI1950A0</td> <td>ST. STEEL 4.2X13 TCB SELF-DRILLIN G SCREW</td> <td>1.000</td> <td>PC</td> </tr> <tr> <td>VM1255A1</td> <td>THREAD-COV ERING CAP MARUTEX</td> <td>1.000</td> <td>PC</td> </tr> </tbody> </table>	Code	Description	Qty	UOM	VI1950A0	ST. STEEL 4.2X13 TCB SELF-DRILLIN G SCREW	1.000	PC	VM1255A1	THREAD-COV ERING CAP MARUTEX	1.000	PC								
Code	Description	Qty	UOM																						
VI1950A0	ST. STEEL 4.2X13 TCB SELF-DRILLIN G SCREW	1.000	PC																						
VM1255A1	THREAD-COV ERING CAP MARUTEX	1.000	PC																						
0H6572B	CHEF-BAKERLUX GAS VALVE SUPPORT		0H6572B0	CHEF-BAKERLUX GAS VALVE SUPPORT																					
EL1414A	TWO-STAGE GAS SOLENOID VALVE		KEL1414A	BISTABLE GAS VALVE KIT	<table border="1"> <thead> <tr> <th>Code</th> <th>Description</th> <th>Qty</th> <th>UOM</th> </tr> </thead> <tbody> <tr> <td>EL1414A0</td> <td>TWO-STAGE GAS SOLENOID VALVE</td> <td>1.000</td> <td>PC</td> </tr> <tr> <td>RC1045A2</td> <td>3/4" FEM-3/4" MALE THREADED STRAIGHT</td> <td>1.000</td> <td>PC</td> </tr> <tr> <td>RC1325B0</td> <td>3/8"-M13x1 INT. 3/4" FLEXIBLE PIPE</td> <td>1.000</td> <td>PC</td> </tr> <tr> <td>VI1130A0</td> <td>ALUMINIUM BUSHING 24x18x1,5 TO HOLD GAS</td> <td>2.000</td> <td>PC</td> </tr> </tbody> </table>	Code	Description	Qty	UOM	EL1414A0	TWO-STAGE GAS SOLENOID VALVE	1.000	PC	RC1045A2	3/4" FEM-3/4" MALE THREADED STRAIGHT	1.000	PC	RC1325B0	3/8"-M13x1 INT. 3/4" FLEXIBLE PIPE	1.000	PC	VI1130A0	ALUMINIUM BUSHING 24x18x1,5 TO HOLD GAS	2.000	PC
Code	Description	Qty	UOM																						
EL1414A0	TWO-STAGE GAS SOLENOID VALVE	1.000	PC																						
RC1045A2	3/4" FEM-3/4" MALE THREADED STRAIGHT	1.000	PC																						
RC1325B0	3/8"-M13x1 INT. 3/4" FLEXIBLE PIPE	1.000	PC																						
VI1130A0	ALUMINIUM BUSHING 24x18x1,5 TO HOLD GAS	2.000	PC																						
VE1060A	COVER FOR VE1055A0		KVE1060A	HONEYWELL IGNITION BOX COVER KIT	<table border="1"> <thead> <tr> <th>Code</th> <th>Description</th> <th>Qty</th> <th>UOM</th> </tr> </thead> <tbody> <tr> <td>VE1060A0</td> <td>COVER FOR VE1055A0</td> <td>1.000</td> <td>PC</td> </tr> </tbody> </table>	Code	Description	Qty	UOM	VE1060A0	COVER FOR VE1055A0	1.000	PC												
Code	Description	Qty	UOM																						
VE1060A0	COVER FOR VE1055A0	1.000	PC																						

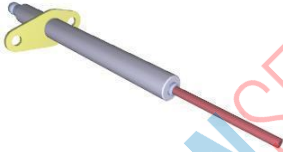
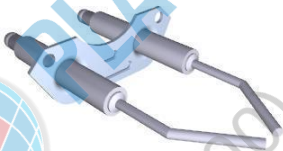
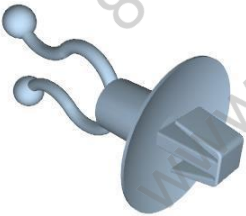
COMPONENT			SPARE PART										
Code	Description	Image	Code	Description	Kit components								
VE1795A	VE1795A0		KVE1795A	ESYS IGNITION BOX GEARCASE KIT	<table border="1"> <thead> <tr> <th>Code</th> <th>Description</th> <th>Qty</th> <th>UOM</th> </tr> </thead> <tbody> <tr> <td>VE1795A0</td> <td>VE1795A0</td> <td>1.000</td> <td>PC</td> </tr> </tbody> </table>	Code	Description	Qty	UOM	VE1795A0	VE1795A0	1.000	PC
Code	Description	Qty	UOM										
VE1795A0	VE1795A0	1.000	PC										
BR1230A	START UP SENSOR CANDLE		KBR1230A	XG SERIES SPARK DETECTION CANDLE KIT	<table border="1"> <thead> <tr> <th>Code</th> <th>Description</th> <th>Qty</th> <th>UOM</th> </tr> </thead> <tbody> <tr> <td>BR1230A0</td> <td>START UP SENSOR CANDLE</td> <td>1.000</td> <td>PC</td> </tr> </tbody> </table>	Code	Description	Qty	UOM	BR1230A0	START UP SENSOR CANDLE	1.000	PC
Code	Description	Qty	UOM										
BR1230A0	START UP SENSOR CANDLE	1.000	PC										
BR1310A	XBC-XVC DOUBLE START UP CANDLE		KBR1310A	DOUBLE START UP CANDLE 2 PCS. KIT	<table border="1"> <thead> <tr> <th>Code</th> <th>Description</th> <th>Qty</th> <th>UOM</th> </tr> </thead> <tbody> <tr> <td>BR1310A0</td> <td>XBC-XVC DOUBLE START UP CANDLE</td> <td>2.000</td> <td>PC</td> </tr> </tbody> </table>	Code	Description	Qty	UOM	BR1310A0	XBC-XVC DOUBLE START UP CANDLE	2.000	PC
Code	Description	Qty	UOM										
BR1310A0	XBC-XVC DOUBLE START UP CANDLE	2.000	PC										
VM1610A	CLIP TWIST LOCK DIAM. 7,6-10,2 MM		VM1605A0	CLIP TWIST LOCK DIAM. 10,2-12,7 MM									

ASM4079A/0.D00 - Door

FRONT



ASM4079A/0.D00 - Door



REAR







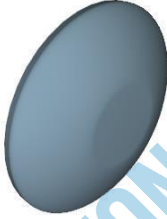

COMPONENT			SPARE PART																																														
Code	Description	Image	Code	Description	Kit components																																												
VM2008A	SPACER FOR MICROSWITCH		KVM2008A	MICROSWITCH SPACER KIT	<table border="1"> <thead> <tr> <th>Code</th> <th>Description</th> <th>Qty</th> <th>UOM</th> </tr> </thead> <tbody> <tr> <td>VM2008A0</td> <td>SPACER FOR MICROSWITC</td> <td>2.000</td> <td>PC</td> </tr> </tbody> </table>	Code	Description	Qty	UOM	VM2008A0	SPACER FOR MICROSWITC	2.000	PC																																				
Code	Description	Qty	UOM																																														
VM2008A0	SPACER FOR MICROSWITC	2.000	PC																																														
CR1085A	INTERNAL GLASS UPPER HINGE		KVM0012A	4-5-5E S. INT. GLASS OPENING SYSTEM KIT	<table border="1"> <thead> <tr> <th>Code</th> <th>Description</th> <th>Qty</th> <th>UOM</th> </tr> </thead> <tbody> <tr> <td>CR1085A0</td> <td>INTERNAL GLASS UPPER HINGE</td> <td>1.000</td> <td>PC</td> </tr> <tr> <td>CR1086A0</td> <td>INTERNAL GLASS LOWER HINGE</td> <td>1.000</td> <td>PC</td> </tr> <tr> <td>GN1181A0</td> <td>INTERNAL GLASS HINGE SEAL</td> <td>2.000</td> <td>PC</td> </tr> <tr> <td>VI1220A1</td> <td>4,2x12 TCB SELF-TAPPIN G SCREW</td> <td>5.000</td> <td>PC</td> </tr> <tr> <td>VI1300A0</td> <td>SCREW M6X12 T1/2T+INOX</td> <td>4.000</td> <td>PC</td> </tr> <tr> <td>VI1810A0</td> <td>M6X6 STAINLESS STEEL FLATHEAD SCREW</td> <td>6.000</td> <td>PC</td> </tr> <tr> <td>VI1950A0</td> <td>ST. STEEL 4,2X13 TCB SELF-DRILLIN G SCREW</td> <td>6.000</td> <td>PC</td> </tr> <tr> <td>VM1680A0</td> <td>INTERNAL GLASS HINGE</td> <td>2.000</td> <td>PC</td> </tr> <tr> <td>VM2042A0</td> <td>INTERNAL GLASS LATERAL LOCKING SYSTEM</td> <td>2.000</td> <td>PC</td> </tr> <tr> <td>VM2043A0</td> <td>UPPER - LOWER GLASS SUPPORT</td> <td>2.000</td> <td>PC</td> </tr> </tbody> </table>	Code	Description	Qty	UOM	CR1085A0	INTERNAL GLASS UPPER HINGE	1.000	PC	CR1086A0	INTERNAL GLASS LOWER HINGE	1.000	PC	GN1181A0	INTERNAL GLASS HINGE SEAL	2.000	PC	VI1220A1	4,2x12 TCB SELF-TAPPIN G SCREW	5.000	PC	VI1300A0	SCREW M6X12 T1/2T+INOX	4.000	PC	VI1810A0	M6X6 STAINLESS STEEL FLATHEAD SCREW	6.000	PC	VI1950A0	ST. STEEL 4,2X13 TCB SELF-DRILLIN G SCREW	6.000	PC	VM1680A0	INTERNAL GLASS HINGE	2.000	PC	VM2042A0	INTERNAL GLASS LATERAL LOCKING SYSTEM	2.000	PC	VM2043A0	UPPER - LOWER GLASS SUPPORT	2.000	PC
Code	Description	Qty	UOM																																														
CR1085A0	INTERNAL GLASS UPPER HINGE	1.000	PC																																														
CR1086A0	INTERNAL GLASS LOWER HINGE	1.000	PC																																														
GN1181A0	INTERNAL GLASS HINGE SEAL	2.000	PC																																														
VI1220A1	4,2x12 TCB SELF-TAPPIN G SCREW	5.000	PC																																														
VI1300A0	SCREW M6X12 T1/2T+INOX	4.000	PC																																														
VI1810A0	M6X6 STAINLESS STEEL FLATHEAD SCREW	6.000	PC																																														
VI1950A0	ST. STEEL 4,2X13 TCB SELF-DRILLIN G SCREW	6.000	PC																																														
VM1680A0	INTERNAL GLASS HINGE	2.000	PC																																														
VM2042A0	INTERNAL GLASS LATERAL LOCKING SYSTEM	2.000	PC																																														
VM2043A0	UPPER - LOWER GLASS SUPPORT	2.000	PC																																														
			KCR1085A	INTERNAL GLASS UPPER HINGE KIT	<table border="1"> <thead> <tr> <th>Code</th> <th>Description</th> <th>Qty</th> <th>UOM</th> </tr> </thead> <tbody> <tr> <td>CR1085A0</td> <td>INTERNAL GLASS UPPER HINGE</td> <td>1.000</td> <td>PC</td> </tr> <tr> <td>GN1181A0</td> <td>INTERNAL GLASS HINGE SEAL</td> <td>1.000</td> <td>PC</td> </tr> <tr> <td>VI1810A0</td> <td>M6X6 STAINLESS STEEL FLATHEAD SCREW</td> <td>3.000</td> <td>PC</td> </tr> </tbody> </table>	Code	Description	Qty	UOM	CR1085A0	INTERNAL GLASS UPPER HINGE	1.000	PC	GN1181A0	INTERNAL GLASS HINGE SEAL	1.000	PC	VI1810A0	M6X6 STAINLESS STEEL FLATHEAD SCREW	3.000	PC																												
Code	Description	Qty	UOM																																														
CR1085A0	INTERNAL GLASS UPPER HINGE	1.000	PC																																														
GN1181A0	INTERNAL GLASS HINGE SEAL	1.000	PC																																														
VI1810A0	M6X6 STAINLESS STEEL FLATHEAD SCREW	3.000	PC																																														

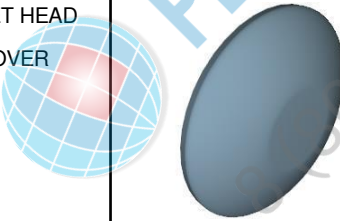

COMPONENT			SPARE PART																																														
Code	Description	Image	Code	Description	Kit components																																												
GN1181A	INTERNAL GLASS HINGE SEAL		KGN1181A	INT. GLASS HINGE GASKET 2 PCS KIT	<table border="1"> <thead> <tr> <th>Code</th> <th>Description</th> <th>Qty</th> <th>UOM</th> </tr> </thead> <tbody> <tr> <td>GN1181A0</td> <td>INTERNAL GLASS HINGE SEAL</td> <td>2.000</td> <td>PC</td> </tr> </tbody> </table>	Code	Description	Qty	UOM	GN1181A0	INTERNAL GLASS HINGE SEAL	2.000	PC																																				
Code	Description	Qty	UOM																																														
GN1181A0	INTERNAL GLASS HINGE SEAL	2.000	PC																																														
VM2000A	M4 SOCKET HEAD SCREW COVER		VM2000A0	M4 SOCKET HEAD SCREW COVER																																													
CR1086A	INTERNAL GLASS LOWER HINGE		KVM0012A	4-5-5E S. INT. GLASS OPENING SYSTEM KIT	<table border="1"> <thead> <tr> <th>Code</th> <th>Description</th> <th>Qty</th> <th>UOM</th> </tr> </thead> <tbody> <tr> <td>CR1085A0</td> <td>INTERNAL GLASS UPPER HINGE</td> <td>1.000</td> <td>PC</td> </tr> <tr> <td>CR1086A0</td> <td>INTERNAL GLASS LOWER HINGE</td> <td>1.000</td> <td>PC</td> </tr> <tr> <td>GN1181A0</td> <td>INTERNAL GLASS HINGE SEAL</td> <td>2.000</td> <td>PC</td> </tr> <tr> <td>VI1220A1</td> <td>4,2x12 TCB SELF-TAPPING SCREW</td> <td>5.000</td> <td>PC</td> </tr> <tr> <td>VI1300A0</td> <td>SCREW M6X12 T1/2T+INOX</td> <td>4.000</td> <td>PC</td> </tr> <tr> <td>VI1810A0</td> <td>M6X6 STAINLESS STEEL FLATHEAD SCREW</td> <td>6.000</td> <td>PC</td> </tr> <tr> <td>VI1950A0</td> <td>ST. STEEL 4,2X13 TCB SELF-DRILLING SCREW</td> <td>6.000</td> <td>PC</td> </tr> <tr> <td>VM1680A0</td> <td>INTERNAL GLASS HINGE</td> <td>2.000</td> <td>PC</td> </tr> <tr> <td>VM2042A0</td> <td>INTERNAL GLASS LATERAL LOCKING SYSTEM</td> <td>2.000</td> <td>PC</td> </tr> <tr> <td>VM2043A0</td> <td>UPPER - LOWER GLASS SUPPORT</td> <td>2.000</td> <td>PC</td> </tr> </tbody> </table>	Code	Description	Qty	UOM	CR1085A0	INTERNAL GLASS UPPER HINGE	1.000	PC	CR1086A0	INTERNAL GLASS LOWER HINGE	1.000	PC	GN1181A0	INTERNAL GLASS HINGE SEAL	2.000	PC	VI1220A1	4,2x12 TCB SELF-TAPPING SCREW	5.000	PC	VI1300A0	SCREW M6X12 T1/2T+INOX	4.000	PC	VI1810A0	M6X6 STAINLESS STEEL FLATHEAD SCREW	6.000	PC	VI1950A0	ST. STEEL 4,2X13 TCB SELF-DRILLING SCREW	6.000	PC	VM1680A0	INTERNAL GLASS HINGE	2.000	PC	VM2042A0	INTERNAL GLASS LATERAL LOCKING SYSTEM	2.000	PC	VM2043A0	UPPER - LOWER GLASS SUPPORT	2.000	PC
Code	Description	Qty	UOM																																														
CR1085A0	INTERNAL GLASS UPPER HINGE	1.000	PC																																														
CR1086A0	INTERNAL GLASS LOWER HINGE	1.000	PC																																														
GN1181A0	INTERNAL GLASS HINGE SEAL	2.000	PC																																														
VI1220A1	4,2x12 TCB SELF-TAPPING SCREW	5.000	PC																																														
VI1300A0	SCREW M6X12 T1/2T+INOX	4.000	PC																																														
VI1810A0	M6X6 STAINLESS STEEL FLATHEAD SCREW	6.000	PC																																														
VI1950A0	ST. STEEL 4,2X13 TCB SELF-DRILLING SCREW	6.000	PC																																														
VM1680A0	INTERNAL GLASS HINGE	2.000	PC																																														
VM2042A0	INTERNAL GLASS LATERAL LOCKING SYSTEM	2.000	PC																																														
VM2043A0	UPPER - LOWER GLASS SUPPORT	2.000	PC																																														

COMPONENT			SPARE PART																		
Code	Description	Image	Code	Description	Kit components																
CR1086A	INTERNAL GLASS LOWER HINGE		KCR1086A	INTERNAL GLASS LOWER HINGE KIT	<table border="1"> <thead> <tr> <th>Code</th> <th>Description</th> <th>Qty</th> <th>UOM</th> </tr> </thead> <tbody> <tr> <td>CR1086A0</td> <td>INTERNAL GLASS LOWER HINGE</td> <td>1.000</td> <td>PC</td> </tr> <tr> <td>GN1181A0</td> <td>INTERNAL GLASS HINGE SEAL</td> <td>1.000</td> <td>PC</td> </tr> <tr> <td>VI1810A0</td> <td>M6X6 STAINLESS STEEL FLATHEAD SCREW</td> <td>3.000</td> <td>PC</td> </tr> </tbody> </table>	Code	Description	Qty	UOM	CR1086A0	INTERNAL GLASS LOWER HINGE	1.000	PC	GN1181A0	INTERNAL GLASS HINGE SEAL	1.000	PC	VI1810A0	M6X6 STAINLESS STEEL FLATHEAD SCREW	3.000	PC
Code	Description	Qty	UOM																		
CR1086A0	INTERNAL GLASS LOWER HINGE	1.000	PC																		
GN1181A0	INTERNAL GLASS HINGE SEAL	1.000	PC																		
VI1810A0	M6X6 STAINLESS STEEL FLATHEAD SCREW	3.000	PC																		
GN1181A	INTERNAL GLASS HINGE SEAL		KGN1181A	INT. GLASS HINGE GASKET 2 PCS KIT	<table border="1"> <thead> <tr> <th>Code</th> <th>Description</th> <th>Qty</th> <th>UOM</th> </tr> </thead> <tbody> <tr> <td>GN1181A0</td> <td>INTERNAL GLASS HINGE SEAL</td> <td>2.000</td> <td>PC</td> </tr> </tbody> </table>	Code	Description	Qty	UOM	GN1181A0	INTERNAL GLASS HINGE SEAL	2.000	PC								
Code	Description	Qty	UOM																		
GN1181A0	INTERNAL GLASS HINGE SEAL	2.000	PC																		
VM2000A	M4 SOCKET HEAD SCREW COVER		VM2000A0	M4 SOCKET HEAD SCREW COVER																	
VT1135A	743x620x6 INNER GLASS		KVT1135A	XB693/5 XBC605 XVC1205 INT. GLASS KIT	<table border="1"> <thead> <tr> <th>Code</th> <th>Description</th> <th>Qty</th> <th>UOM</th> </tr> </thead> <tbody> <tr> <td>VT1135A0</td> <td>743x620x6 INNER GLASS</td> <td>1.000</td> <td>PC</td> </tr> </tbody> </table>	Code	Description	Qty	UOM	VT1135A0	743x620x6 INNER GLASS	1.000	PC								
Code	Description	Qty	UOM																		
VT1135A0	743x620x6 INNER GLASS	1.000	PC																		
			KDR1136B	XBC605/XVC1205P COMPLETE DOOR	<table border="1"> <thead> <tr> <th>Code</th> <th>Description</th> <th>Qty</th> <th>UOM</th> </tr> </thead> <tbody> <tr> <td>0H2650A0</td> <td>XBC/XVC ST. STEEL INTERNAL GLASS HINGE</td> <td>2.000</td> <td>PC</td> </tr> <tr> <td>0H2655A1</td> <td>STAINL. STEEL DRIP DRAIN TUBE INT-D=6</td> <td>1.000</td> <td>PC</td> </tr> <tr> <td>0H4277A0</td> <td>XVC505 EXTERNAL GLASS HOLDING PROFILE</td> <td>2.000</td> <td>PC</td> </tr> </tbody> </table>	Code	Description	Qty	UOM	0H2650A0	XBC/XVC ST. STEEL INTERNAL GLASS HINGE	2.000	PC	0H2655A1	STAINL. STEEL DRIP DRAIN TUBE INT-D=6	1.000	PC	0H4277A0	XVC505 EXTERNAL GLASS HOLDING PROFILE	2.000	PC
Code	Description	Qty	UOM																		
0H2650A0	XBC/XVC ST. STEEL INTERNAL GLASS HINGE	2.000	PC																		
0H2655A1	STAINL. STEEL DRIP DRAIN TUBE INT-D=6	1.000	PC																		
0H4277A0	XVC505 EXTERNAL GLASS HOLDING PROFILE	2.000	PC																		



COMPONENT			SPARE PART																																																																						
Code	Description	Image	Code	Description	Kit components																																																																				
VT1135A	743x620x6 INNER GLASS		KDR1136B	XBC605/XVC1205P COMPLETE DOOR	<table border="1"> <thead> <tr> <th>Code</th> <th>Description</th> <th>Qty</th> <th>UOM</th> </tr> </thead> <tbody> <tr> <td>0H4310A0</td> <td>ST. STEEL HEAT-GUARD FOR CONTROL PANEL</td> <td>1.000</td> <td>PC</td> </tr> <tr> <td>CE1275A0</td> <td>3M POWER - CONTROL CONNECTION CABLE</td> <td>1.000</td> <td>PC</td> </tr> <tr> <td>CE1285A0</td> <td>EMI ROUND FERRITE MOD.26438015 02</td> <td>2.000</td> <td>PC</td> </tr> <tr> <td>CE1290A0</td> <td>EXTRACTABL E FEMALE TERMINAL CPF 5/4</td> <td>2.000</td> <td>PC</td> </tr> <tr> <td>CE1310A1</td> <td>POWER - CONTROL BOARD CONNECTING CABLE</td> <td>1.000</td> <td>PC</td> </tr> <tr> <td>CE1665A0</td> <td>LED POWER SUPPLY 1 M CABLE</td> <td>1.000</td> <td>PC</td> </tr> <tr> <td>GN1180A0</td> <td>INTERNAL GLASS HINGE CARBOGRAPH ITE</td> <td>4.000</td> <td>PC</td> </tr> <tr> <td>LP1002B0</td> <td>LED LIGHTING BAR L400</td> <td>1.000</td> <td>PC</td> </tr> <tr> <td>MG1030B2</td> <td>CT-BT DOOR HANDLE</td> <td>1.000</td> <td>PC</td> </tr> <tr> <td>SL1110A0</td> <td>BIADHESIVE PIN 3M VHB 9473-PC</td> <td>1.000</td> <td>PC</td> </tr> <tr> <td>SL1155A1</td> <td>LOCTITE BICOMPONENT SILICON</td> <td>24.000</td> <td>ML</td> </tr> <tr> <td>TB1190A0</td> <td>XVC505 XBC605 RIGHT DOOR COLUM</td> <td>1.000</td> <td>PC</td> </tr> <tr> <td>TB1191A1</td> <td>XVC505 XBC605 LEFT DOOR COLUM</td> <td>1.000</td> <td>PC</td> </tr> <tr> <td>TB1225A0</td> <td>XBC405/605/80 5 DOOR UPPER LISTEL</td> <td>1.000</td> <td>PC</td> </tr> <tr> <td>TB1226A0</td> <td>XBC405/605/80 5 DOOR LOWER LISTE</td> <td>1.000</td> <td>PC</td> </tr> <tr> <td>TF1010A0</td> <td>TEFLON BUSHING FOR INTERNAL GLASS</td> <td>2.000</td> <td>PC</td> </tr> </tbody> </table>	Code	Description	Qty	UOM	0H4310A0	ST. STEEL HEAT-GUARD FOR CONTROL PANEL	1.000	PC	CE1275A0	3M POWER - CONTROL CONNECTION CABLE	1.000	PC	CE1285A0	EMI ROUND FERRITE MOD.26438015 02	2.000	PC	CE1290A0	EXTRACTABL E FEMALE TERMINAL CPF 5/4	2.000	PC	CE1310A1	POWER - CONTROL BOARD CONNECTING CABLE	1.000	PC	CE1665A0	LED POWER SUPPLY 1 M CABLE	1.000	PC	GN1180A0	INTERNAL GLASS HINGE CARBOGRAPH ITE	4.000	PC	LP1002B0	LED LIGHTING BAR L400	1.000	PC	MG1030B2	CT-BT DOOR HANDLE	1.000	PC	SL1110A0	BIADHESIVE PIN 3M VHB 9473-PC	1.000	PC	SL1155A1	LOCTITE BICOMPONENT SILICON	24.000	ML	TB1190A0	XVC505 XBC605 RIGHT DOOR COLUM	1.000	PC	TB1191A1	XVC505 XBC605 LEFT DOOR COLUM	1.000	PC	TB1225A0	XBC405/605/80 5 DOOR UPPER LISTEL	1.000	PC	TB1226A0	XBC405/605/80 5 DOOR LOWER LISTE	1.000	PC	TF1010A0	TEFLON BUSHING FOR INTERNAL GLASS	2.000	PC
Code	Description	Qty	UOM																																																																						
0H4310A0	ST. STEEL HEAT-GUARD FOR CONTROL PANEL	1.000	PC																																																																						
CE1275A0	3M POWER - CONTROL CONNECTION CABLE	1.000	PC																																																																						
CE1285A0	EMI ROUND FERRITE MOD.26438015 02	2.000	PC																																																																						
CE1290A0	EXTRACTABL E FEMALE TERMINAL CPF 5/4	2.000	PC																																																																						
CE1310A1	POWER - CONTROL BOARD CONNECTING CABLE	1.000	PC																																																																						
CE1665A0	LED POWER SUPPLY 1 M CABLE	1.000	PC																																																																						
GN1180A0	INTERNAL GLASS HINGE CARBOGRAPH ITE	4.000	PC																																																																						
LP1002B0	LED LIGHTING BAR L400	1.000	PC																																																																						
MG1030B2	CT-BT DOOR HANDLE	1.000	PC																																																																						
SL1110A0	BIADHESIVE PIN 3M VHB 9473-PC	1.000	PC																																																																						
SL1155A1	LOCTITE BICOMPONENT SILICON	24.000	ML																																																																						
TB1190A0	XVC505 XBC605 RIGHT DOOR COLUM	1.000	PC																																																																						
TB1191A1	XVC505 XBC605 LEFT DOOR COLUM	1.000	PC																																																																						
TB1225A0	XBC405/605/80 5 DOOR UPPER LISTEL	1.000	PC																																																																						
TB1226A0	XBC405/605/80 5 DOOR LOWER LISTE	1.000	PC																																																																						
TF1010A0	TEFLON BUSHING FOR INTERNAL GLASS	2.000	PC																																																																						





PLATON SERVICE
8 (800) 500-34-47
www.platonservice.com





COMPONENT			SPARE PART																																																																										
Code	Description	Image	Code	Description	Kit components																																																																								
VT1135A	743x620x6 INNER GLASS		KDR1136B	XBC605/XVC1205P COMPLETE DOOR	<table border="1"> <thead> <tr> <th>Code</th> <th>Description</th> <th>Qty</th> <th>UOM</th> </tr> </thead> <tbody> <tr> <td>VE1030A1</td> <td>MAGNET FOR DOOR MICROSWITC H D=22.9mm</td> <td>2.000</td> <td>PC</td> </tr> <tr> <td>VI0239A1</td> <td>SELF-TAPPIN G SCREW 4.2X25 TCB+ INOX</td> <td>4.000</td> <td>PC</td> </tr> <tr> <td>VI1070A0</td> <td>SCREW M4x16 TSP/UNI7688 INOX</td> <td>2.000</td> <td>PC</td> </tr> <tr> <td>VI1075A0</td> <td>NUT M4 H=4 UNI5587 INOX</td> <td>2.000</td> <td>PC</td> </tr> <tr> <td>VI1220A1</td> <td>4.2x12 TCB SELF-TAPPIN G SCREW</td> <td>19.000</td> <td>PC</td> </tr> <tr> <td>VI1300A0</td> <td>SCREW M6x12 T1/2+INOX</td> <td>12.000</td> <td>PC</td> </tr> <tr> <td>VI1310A0</td> <td>ZINC THREAD INSERT M6 FTR/E</td> <td>8.000</td> <td>PC</td> </tr> <tr> <td>VI1340A0</td> <td>M6 ST. STEEL THREADED INSERT</td> <td>4.000</td> <td>PC</td> </tr> <tr> <td>VI1810A0</td> <td>M6X6 STAINLESS STEEL FLATHEAD SCREW</td> <td>12.000</td> <td>PC</td> </tr> <tr> <td>VI1895A0</td> <td>BLIND NUT M4 STAINLESS STEEL DIN 917</td> <td>6.000</td> <td>PC</td> </tr> <tr> <td>VI1945A0</td> <td>ENG-VITE M4x20 TCB+ INOX</td> <td>6.000</td> <td>PC</td> </tr> <tr> <td>VM1145A1</td> <td>C.T. BOARD FRAME</td> <td>1.000</td> <td>PC</td> </tr> <tr> <td>VM1170B0</td> <td>UPPER DOOR FULCRUM CA</td> <td>1.000</td> <td>PC</td> </tr> <tr> <td>VM1171B0</td> <td>DOOR LOWER FULCRUM CA</td> <td>1.000</td> <td>PC</td> </tr> <tr> <td>VM1175A0</td> <td>DOOR COLUMN BLANKING CA</td> <td>2.000</td> <td>PC</td> </tr> <tr> <td>VM1207A0</td> <td>DOOR DROP PRESERVER FORM XBC404/604/80</td> <td>1.000</td> <td>PC</td> </tr> <tr> <td>VM1230A0</td> <td>UPPER ALUMINIUM HINGE FOR INTERNAL</td> <td>2.000</td> <td>PC</td> </tr> </tbody> </table>	Code	Description	Qty	UOM	VE1030A1	MAGNET FOR DOOR MICROSWITC H D=22.9mm	2.000	PC	VI0239A1	SELF-TAPPIN G SCREW 4.2X25 TCB+ INOX	4.000	PC	VI1070A0	SCREW M4x16 TSP/UNI7688 INOX	2.000	PC	VI1075A0	NUT M4 H=4 UNI5587 INOX	2.000	PC	VI1220A1	4.2x12 TCB SELF-TAPPIN G SCREW	19.000	PC	VI1300A0	SCREW M6x12 T1/2+INOX	12.000	PC	VI1310A0	ZINC THREAD INSERT M6 FTR/E	8.000	PC	VI1340A0	M6 ST. STEEL THREADED INSERT	4.000	PC	VI1810A0	M6X6 STAINLESS STEEL FLATHEAD SCREW	12.000	PC	VI1895A0	BLIND NUT M4 STAINLESS STEEL DIN 917	6.000	PC	VI1945A0	ENG-VITE M4x20 TCB+ INOX	6.000	PC	VM1145A1	C.T. BOARD FRAME	1.000	PC	VM1170B0	UPPER DOOR FULCRUM CA	1.000	PC	VM1171B0	DOOR LOWER FULCRUM CA	1.000	PC	VM1175A0	DOOR COLUMN BLANKING CA	2.000	PC	VM1207A0	DOOR DROP PRESERVER FORM XBC404/604/80	1.000	PC	VM1230A0	UPPER ALUMINIUM HINGE FOR INTERNAL	2.000	PC
Code	Description	Qty	UOM																																																																										
VE1030A1	MAGNET FOR DOOR MICROSWITC H D=22.9mm	2.000	PC																																																																										
VI0239A1	SELF-TAPPIN G SCREW 4.2X25 TCB+ INOX	4.000	PC																																																																										
VI1070A0	SCREW M4x16 TSP/UNI7688 INOX	2.000	PC																																																																										
VI1075A0	NUT M4 H=4 UNI5587 INOX	2.000	PC																																																																										
VI1220A1	4.2x12 TCB SELF-TAPPIN G SCREW	19.000	PC																																																																										
VI1300A0	SCREW M6x12 T1/2+INOX	12.000	PC																																																																										
VI1310A0	ZINC THREAD INSERT M6 FTR/E	8.000	PC																																																																										
VI1340A0	M6 ST. STEEL THREADED INSERT	4.000	PC																																																																										
VI1810A0	M6X6 STAINLESS STEEL FLATHEAD SCREW	12.000	PC																																																																										
VI1895A0	BLIND NUT M4 STAINLESS STEEL DIN 917	6.000	PC																																																																										
VI1945A0	ENG-VITE M4x20 TCB+ INOX	6.000	PC																																																																										
VM1145A1	C.T. BOARD FRAME	1.000	PC																																																																										
VM1170B0	UPPER DOOR FULCRUM CA	1.000	PC																																																																										
VM1171B0	DOOR LOWER FULCRUM CA	1.000	PC																																																																										
VM1175A0	DOOR COLUMN BLANKING CA	2.000	PC																																																																										
VM1207A0	DOOR DROP PRESERVER FORM XBC404/604/80	1.000	PC																																																																										
VM1230A0	UPPER ALUMINIUM HINGE FOR INTERNAL	2.000	PC																																																																										



COMPONENT			SPARE PART																																														
Code	Description	Image	Code	Description	Kit components																																												
VT1135A	743x620x6 INNER GLASS		KDR1136B	XBC605/XVC1205P COMPLETE DOOR	<table border="1"> <thead> <tr> <th>Code</th> <th>Description</th> <th>Qty</th> <th>UOM</th> </tr> </thead> <tbody> <tr> <td>VM1231A0</td> <td>LOWER ALUMINIUM HINGE FOR INTERNAL</td> <td>2.000</td> <td>PC</td> </tr> <tr> <td>VM1235A0</td> <td>UPPER HOOK TO STOP INNER GLASS</td> <td>1.000</td> <td>PC</td> </tr> <tr> <td>VM1236A0</td> <td>LOWER HOOK TO STOP INNER GLASS</td> <td>1.000</td> <td>PC</td> </tr> <tr> <td>VM1490A0</td> <td>CHEFTOP/BAK ERTOP HANDLE SCREWS COVER</td> <td>2.000</td> <td>PC</td> </tr> <tr> <td>VM1510A0</td> <td>XBC/XVC GROOVED DOOR PIN BUSHING</td> <td>1.000</td> <td>PC</td> </tr> <tr> <td>VM1511A0</td> <td>XBC/XVC SLEEK DOOR PIN BUSHING</td> <td>1.000</td> <td>PC</td> </tr> <tr> <td>VM1620A0</td> <td>LED BAR LOWER SUPPORT</td> <td>1.000</td> <td>PC</td> </tr> <tr> <td>VM1621A0</td> <td>LED BAR UPPER SUPPORT</td> <td>1.000</td> <td>PC</td> </tr> <tr> <td>VT1135A0</td> <td>743x620x6 INNER GLASS</td> <td>1.000</td> <td>PC</td> </tr> <tr> <td>VT1136B0</td> <td>SILKSCREENE D EXTERNAL GLASS 757X743X4</td> <td>1.000</td> <td>PC</td> </tr> </tbody> </table>	Code	Description	Qty	UOM	VM1231A0	LOWER ALUMINIUM HINGE FOR INTERNAL	2.000	PC	VM1235A0	UPPER HOOK TO STOP INNER GLASS	1.000	PC	VM1236A0	LOWER HOOK TO STOP INNER GLASS	1.000	PC	VM1490A0	CHEFTOP/BAK ERTOP HANDLE SCREWS COVER	2.000	PC	VM1510A0	XBC/XVC GROOVED DOOR PIN BUSHING	1.000	PC	VM1511A0	XBC/XVC SLEEK DOOR PIN BUSHING	1.000	PC	VM1620A0	LED BAR LOWER SUPPORT	1.000	PC	VM1621A0	LED BAR UPPER SUPPORT	1.000	PC	VT1135A0	743x620x6 INNER GLASS	1.000	PC	VT1136B0	SILKSCREENE D EXTERNAL GLASS 757X743X4	1.000	PC
					Code	Description	Qty	UOM																																									
					VM1231A0	LOWER ALUMINIUM HINGE FOR INTERNAL	2.000	PC																																									
					VM1235A0	UPPER HOOK TO STOP INNER GLASS	1.000	PC																																									
					VM1236A0	LOWER HOOK TO STOP INNER GLASS	1.000	PC																																									
					VM1490A0	CHEFTOP/BAK ERTOP HANDLE SCREWS COVER	2.000	PC																																									
					VM1510A0	XBC/XVC GROOVED DOOR PIN BUSHING	1.000	PC																																									
					VM1511A0	XBC/XVC SLEEK DOOR PIN BUSHING	1.000	PC																																									
					VM1620A0	LED BAR LOWER SUPPORT	1.000	PC																																									
					VM1621A0	LED BAR UPPER SUPPORT	1.000	PC																																									
					VT1135A0	743x620x6 INNER GLASS	1.000	PC																																									
					VT1136B0	SILKSCREENE D EXTERNAL GLASS 757X743X4	1.000	PC																																									
					LP1044A	LUX LED BAR		KLP1044A	LUX LED BAR KIT	<table border="1"> <thead> <tr> <th>Code</th> <th>Description</th> <th>Qty</th> <th>UOM</th> </tr> </thead> <tbody> <tr> <td>CE1455A0</td> <td>TIP END FITTING</td> <td>2.000</td> <td>PC</td> </tr> <tr> <td>CE1730A0</td> <td>PVC CABLE NP 2 X AWG22 STYLE 2095</td> <td>1.000</td> <td>M</td> </tr> <tr> <td>CE1735A0</td> <td>MINIFIT FEMALE END FITTING</td> <td>2.000</td> <td>PC</td> </tr> <tr> <td>CE1740A0</td> <td>MINIFIT MALE END FITTING</td> <td>2.000</td> <td>PC</td> </tr> <tr> <td>CE1745A0</td> <td>2 WAYS FEMALE MINIFIT CONNECTOR</td> <td>1.000</td> <td>PC</td> </tr> <tr> <td>CE1750A0</td> <td>3 WAYS MALE MINIFIT CONNECTOR</td> <td>1.000</td> <td>PC</td> </tr> <tr> <td>LP1044A0</td> <td>LUX LED BAR</td> <td>1.000</td> <td>PC</td> </tr> </tbody> </table>	Code	Description	Qty	UOM	CE1455A0	TIP END FITTING	2.000	PC	CE1730A0	PVC CABLE NP 2 X AWG22 STYLE 2095	1.000	M	CE1735A0	MINIFIT FEMALE END FITTING	2.000	PC	CE1740A0	MINIFIT MALE END FITTING	2.000	PC	CE1745A0	2 WAYS FEMALE MINIFIT CONNECTOR	1.000	PC	CE1750A0	3 WAYS MALE MINIFIT CONNECTOR	1.000	PC	LP1044A0	LUX LED BAR	1.000	PC							
Code	Description	Qty	UOM																																														
CE1455A0	TIP END FITTING	2.000	PC																																														
CE1730A0	PVC CABLE NP 2 X AWG22 STYLE 2095	1.000	M																																														
CE1735A0	MINIFIT FEMALE END FITTING	2.000	PC																																														
CE1740A0	MINIFIT MALE END FITTING	2.000	PC																																														
CE1745A0	2 WAYS FEMALE MINIFIT CONNECTOR	1.000	PC																																														
CE1750A0	3 WAYS MALE MINIFIT CONNECTOR	1.000	PC																																														
LP1044A0	LUX LED BAR	1.000	PC																																														



COMPONENT			SPARE PART																																																																													
Code	Description	Image	Code	Description	Kit components																																																																											
LP1044A	LUX LED BAR		KLP1044A	LUX LED BAR KIT	<table border="1"> <thead> <tr> <th>Code</th> <th>Description</th> <th>Qty</th> <th>UOM</th> </tr> </thead> <tbody> <tr> <td>VM1620A0</td> <td>LED BAR LOWER SUPPORT</td> <td>1.000</td> <td>PC</td> </tr> <tr> <td>VM1621A0</td> <td>LED BAR UPPER SUPPORT</td> <td>1.000</td> <td>PC</td> </tr> </tbody> </table>	Code	Description	Qty	UOM	VM1620A0	LED BAR LOWER SUPPORT	1.000	PC	VM1621A0	LED BAR UPPER SUPPORT	1.000	PC																																																															
Code	Description	Qty	UOM																																																																													
VM1620A0	LED BAR LOWER SUPPORT	1.000	PC																																																																													
VM1621A0	LED BAR UPPER SUPPORT	1.000	PC																																																																													
VM1620A	LED BAR LOWER SUPPORT		KLP1044A	LUX LED BAR KIT	<table border="1"> <thead> <tr> <th>Code</th> <th>Description</th> <th>Qty</th> <th>UOM</th> </tr> </thead> <tbody> <tr> <td>CE1455A0</td> <td>TIP END FITTING</td> <td>2.000</td> <td>PC</td> </tr> <tr> <td>CE1730A0</td> <td>PVC CABLE NP 2 X AWG22 STYLE 2095</td> <td>1.000</td> <td>M</td> </tr> <tr> <td>CE1735A0</td> <td>MINIFIT FEMALE END FITTING</td> <td>2.000</td> <td>PC</td> </tr> <tr> <td>CE1740A0</td> <td>MINIFIT MALE END FITTING</td> <td>2.000</td> <td>PC</td> </tr> <tr> <td>CE1745A0</td> <td>2 WAYS FEMALE MINIFIT CONNECTOR</td> <td>1.000</td> <td>PC</td> </tr> <tr> <td>CE1750A0</td> <td>3 WAYS MALE MINIFIT CONNECTOR</td> <td>1.000</td> <td>PC</td> </tr> <tr> <td>LP1044A0</td> <td>LUX LED BAR</td> <td>1.000</td> <td>PC</td> </tr> <tr> <td>VM1620A0</td> <td>LED BAR LOWER SUPPORT</td> <td>1.000</td> <td>PC</td> </tr> <tr> <td>VM1621A0</td> <td>LED BAR UPPER SUPPORT</td> <td>1.000</td> <td>PC</td> </tr> </tbody> </table>	Code	Description	Qty	UOM	CE1455A0	TIP END FITTING	2.000	PC	CE1730A0	PVC CABLE NP 2 X AWG22 STYLE 2095	1.000	M	CE1735A0	MINIFIT FEMALE END FITTING	2.000	PC	CE1740A0	MINIFIT MALE END FITTING	2.000	PC	CE1745A0	2 WAYS FEMALE MINIFIT CONNECTOR	1.000	PC	CE1750A0	3 WAYS MALE MINIFIT CONNECTOR	1.000	PC	LP1044A0	LUX LED BAR	1.000	PC	VM1620A0	LED BAR LOWER SUPPORT	1.000	PC	VM1621A0	LED BAR UPPER SUPPORT	1.000	PC	KLP1007A	L200 LED BAR KIT	<table border="1"> <thead> <tr> <th>Code</th> <th>Description</th> <th>Qty</th> <th>UOM</th> </tr> </thead> <tbody> <tr> <td>CE1455A0</td> <td>TIP END FITTING</td> <td>2.000</td> <td>PC</td> </tr> <tr> <td>CE1730A0</td> <td>PVC CABLE NP 2 X AWG22 STYLE 2095</td> <td>1.000</td> <td>M</td> </tr> <tr> <td>CE1735A0</td> <td>MINIFIT FEMALE END FITTING</td> <td>2.000</td> <td>PC</td> </tr> <tr> <td>CE1740A0</td> <td>MINIFIT MALE END FITTING</td> <td>2.000</td> <td>PC</td> </tr> <tr> <td>CE1745A0</td> <td>2 WAYS FEMALE MINIFIT CONNECTOR</td> <td>1.000</td> <td>PC</td> </tr> <tr> <td>CE1750A0</td> <td>3 WAYS MALE MINIFIT CONNECTOR</td> <td>1.000</td> <td>PC</td> </tr> <tr> <td>LP1007A0</td> <td>LED LIGHT BAR L200</td> <td>1.000</td> <td>PC</td> </tr> </tbody> </table>	Code	Description	Qty	UOM	CE1455A0	TIP END FITTING	2.000	PC	CE1730A0	PVC CABLE NP 2 X AWG22 STYLE 2095	1.000	M	CE1735A0	MINIFIT FEMALE END FITTING	2.000	PC	CE1740A0	MINIFIT MALE END FITTING	2.000	PC	CE1745A0	2 WAYS FEMALE MINIFIT CONNECTOR	1.000	PC	CE1750A0	3 WAYS MALE MINIFIT CONNECTOR	1.000	PC	LP1007A0	LED LIGHT BAR L200	1.000	PC
Code	Description	Qty	UOM																																																																													
CE1455A0	TIP END FITTING	2.000	PC																																																																													
CE1730A0	PVC CABLE NP 2 X AWG22 STYLE 2095	1.000	M																																																																													
CE1735A0	MINIFIT FEMALE END FITTING	2.000	PC																																																																													
CE1740A0	MINIFIT MALE END FITTING	2.000	PC																																																																													
CE1745A0	2 WAYS FEMALE MINIFIT CONNECTOR	1.000	PC																																																																													
CE1750A0	3 WAYS MALE MINIFIT CONNECTOR	1.000	PC																																																																													
LP1044A0	LUX LED BAR	1.000	PC																																																																													
VM1620A0	LED BAR LOWER SUPPORT	1.000	PC																																																																													
VM1621A0	LED BAR UPPER SUPPORT	1.000	PC																																																																													
Code	Description	Qty	UOM																																																																													
CE1455A0	TIP END FITTING	2.000	PC																																																																													
CE1730A0	PVC CABLE NP 2 X AWG22 STYLE 2095	1.000	M																																																																													
CE1735A0	MINIFIT FEMALE END FITTING	2.000	PC																																																																													
CE1740A0	MINIFIT MALE END FITTING	2.000	PC																																																																													
CE1745A0	2 WAYS FEMALE MINIFIT CONNECTOR	1.000	PC																																																																													
CE1750A0	3 WAYS MALE MINIFIT CONNECTOR	1.000	PC																																																																													
LP1007A0	LED LIGHT BAR L200	1.000	PC																																																																													



COMPONENT			SPARE PART																																			
Code	Description	Image	Code	Description	Kit components																																	
VM1620A	LED BAR LOWER SUPPORT		KLP1007A	L200 LED BAR KIT	<table border="1"> <thead> <tr> <th>Code</th> <th>Description</th> <th>Qty</th> <th>UOM</th> </tr> </thead> <tbody> <tr> <td>VM1620A0</td> <td>LED BAR LOWER SUPPORT</td> <td>1.000</td> <td>PC</td> </tr> <tr> <td>VM1621A0</td> <td>LED BAR UPPER SUPPORT</td> <td>1.000</td> <td>PC</td> </tr> </tbody> </table>	Code	Description	Qty	UOM	VM1620A0	LED BAR LOWER SUPPORT	1.000	PC	VM1621A0	LED BAR UPPER SUPPORT	1.000	PC																					
			Code	Description	Qty	UOM																																
			VM1620A0	LED BAR LOWER SUPPORT	1.000	PC																																
VM1621A0	LED BAR UPPER SUPPORT	1.000	PC																																			
KLP1004B	L1000 LED BAR KIT	<table border="1"> <thead> <tr> <th>Code</th> <th>Description</th> <th>Qty</th> <th>UOM</th> </tr> </thead> <tbody> <tr> <td>CE1730A0</td> <td>PVC CABLE NP 2 X AWG22 STYLE 2095</td> <td>1.000</td> <td>M</td> </tr> <tr> <td>CE1735A0</td> <td>MINIFIT FEMALE END FITTING</td> <td>2.000</td> <td>PC</td> </tr> <tr> <td>CE1740A0</td> <td>MINIFIT MALE END FITTING</td> <td>2.000</td> <td>PC</td> </tr> <tr> <td>CE1745A0</td> <td>2 WAYS FEMALE MINIFIT CONNECTOR</td> <td>1.000</td> <td>PC</td> </tr> <tr> <td>CE1750A0</td> <td>3 WAYS MALE MINIFIT CONNECTOR</td> <td>1.000</td> <td>PC</td> </tr> <tr> <td>LP1004B0</td> <td>LEB LIGHTING BAR L1000</td> <td>1.000</td> <td>PC</td> </tr> <tr> <td>VM1620A0</td> <td>LED BAR LOWER SUPPORT</td> <td>1.000</td> <td>PC</td> </tr> <tr> <td>VM1621A0</td> <td>LED BAR UPPER SUPPORT</td> <td>1.000</td> <td>PC</td> </tr> </tbody> </table>	Code	Description	Qty	UOM	CE1730A0	PVC CABLE NP 2 X AWG22 STYLE 2095	1.000	M	CE1735A0	MINIFIT FEMALE END FITTING	2.000	PC	CE1740A0	MINIFIT MALE END FITTING	2.000	PC	CE1745A0	2 WAYS FEMALE MINIFIT CONNECTOR	1.000	PC	CE1750A0	3 WAYS MALE MINIFIT CONNECTOR	1.000	PC	LP1004B0	LEB LIGHTING BAR L1000	1.000	PC	VM1620A0	LED BAR LOWER SUPPORT	1.000	PC	VM1621A0	LED BAR UPPER SUPPORT	1.000	PC
Code	Description	Qty	UOM																																			
CE1730A0	PVC CABLE NP 2 X AWG22 STYLE 2095	1.000	M																																			
CE1735A0	MINIFIT FEMALE END FITTING	2.000	PC																																			
CE1740A0	MINIFIT MALE END FITTING	2.000	PC																																			
CE1745A0	2 WAYS FEMALE MINIFIT CONNECTOR	1.000	PC																																			
CE1750A0	3 WAYS MALE MINIFIT CONNECTOR	1.000	PC																																			
LP1004B0	LEB LIGHTING BAR L1000	1.000	PC																																			
VM1620A0	LED BAR LOWER SUPPORT	1.000	PC																																			
VM1621A0	LED BAR UPPER SUPPORT	1.000	PC																																			
KLP1003B	2017 LED BAR KIT	<table border="1"> <thead> <tr> <th>Code</th> <th>Description</th> <th>Qty</th> <th>UOM</th> </tr> </thead> <tbody> <tr> <td>CE1730A0</td> <td>PVC CABLE NP 2 X AWG22 STYLE 2095</td> <td>1.000</td> <td>M</td> </tr> <tr> <td>CE1735A0</td> <td>MINIFIT FEMALE END FITTING</td> <td>2.000</td> <td>PC</td> </tr> <tr> <td>CE1740A0</td> <td>MINIFIT MALE END FITTING</td> <td>2.000</td> <td>PC</td> </tr> <tr> <td>CE1745A0</td> <td>2 WAYS FEMALE MINIFIT CONNECTOR</td> <td>1.000</td> <td>PC</td> </tr> <tr> <td>CE1750A0</td> <td>3 WAYS MALE MINIFIT CONNECTOR</td> <td>1.000</td> <td>PC</td> </tr> <tr> <td>LP1003B0</td> <td>LED LIGHT BAR L600</td> <td>1.000</td> <td>PC</td> </tr> <tr> <td>VM1620A0</td> <td>LED BAR LOWER SUPPORT</td> <td>1.000</td> <td>PC</td> </tr> <tr> <td>VM1621A0</td> <td>LED BAR UPPER SUPPORT</td> <td>1.000</td> <td>PC</td> </tr> </tbody> </table>	Code	Description	Qty	UOM	CE1730A0	PVC CABLE NP 2 X AWG22 STYLE 2095	1.000	M	CE1735A0	MINIFIT FEMALE END FITTING	2.000	PC	CE1740A0	MINIFIT MALE END FITTING	2.000	PC	CE1745A0	2 WAYS FEMALE MINIFIT CONNECTOR	1.000	PC	CE1750A0	3 WAYS MALE MINIFIT CONNECTOR	1.000	PC	LP1003B0	LED LIGHT BAR L600	1.000	PC	VM1620A0	LED BAR LOWER SUPPORT	1.000	PC	VM1621A0	LED BAR UPPER SUPPORT	1.000	PC
Code	Description	Qty	UOM																																			
CE1730A0	PVC CABLE NP 2 X AWG22 STYLE 2095	1.000	M																																			
CE1735A0	MINIFIT FEMALE END FITTING	2.000	PC																																			
CE1740A0	MINIFIT MALE END FITTING	2.000	PC																																			
CE1745A0	2 WAYS FEMALE MINIFIT CONNECTOR	1.000	PC																																			
CE1750A0	3 WAYS MALE MINIFIT CONNECTOR	1.000	PC																																			
LP1003B0	LED LIGHT BAR L600	1.000	PC																																			
VM1620A0	LED BAR LOWER SUPPORT	1.000	PC																																			
VM1621A0	LED BAR UPPER SUPPORT	1.000	PC																																			



COMPONENT			SPARE PART																																							
Code	Description	Image	Code	Description	Kit components																																					
VM1620A	LED BAR LOWER SUPPORT		KLP1003B	2017 LED BAR KIT	<table border="1"> <thead> <tr> <th>Code</th> <th>Description</th> <th>Qty</th> <th>UOM</th> </tr> </thead> <tbody> <tr> <td>VM1794A0</td> <td>250x4.8 PA66 BLACK CLAMP</td> <td>2.000</td> <td>PC</td> </tr> <tr> <td>VM2103A0</td> <td>CLAMP LOCK</td> <td>2.000</td> <td>PC</td> </tr> </tbody> </table>	Code	Description	Qty	UOM	VM1794A0	250x4.8 PA66 BLACK CLAMP	2.000	PC	VM2103A0	CLAMP LOCK	2.000	PC																									
			Code	Description	Qty	UOM																																				
			VM1794A0	250x4.8 PA66 BLACK CLAMP	2.000	PC																																				
VM2103A0	CLAMP LOCK	2.000	PC																																							
KLP1002B	L400 LED BAR KIT	<table border="1"> <thead> <tr> <th>Code</th> <th>Description</th> <th>Qty</th> <th>UOM</th> </tr> </thead> <tbody> <tr> <td>CE1455A0</td> <td>TIP END FITTING</td> <td>2.000</td> <td>PC</td> </tr> <tr> <td>CE1730A0</td> <td>PVC CABLE NP 2 X AWG22 STYLE 2095</td> <td>1.000</td> <td>M</td> </tr> <tr> <td>CE1735A0</td> <td>MINIFIT FEMALE END FITTING</td> <td>2.000</td> <td>PC</td> </tr> <tr> <td>CE1740A0</td> <td>MINIFIT MALE END FITTING</td> <td>2.000</td> <td>PC</td> </tr> <tr> <td>CE1745A0</td> <td>2 WAYS FEMALE MINIFIT CONNECTOR</td> <td>1.000</td> <td>PC</td> </tr> <tr> <td>CE1750A0</td> <td>3 WAYS MALE MINIFIT CONNECTOR</td> <td>1.000</td> <td>PC</td> </tr> <tr> <td>LP1002B0</td> <td>LED LIGHTING BAR L400</td> <td>1.000</td> <td>PC</td> </tr> <tr> <td>VM1620A0</td> <td>LED BAR LOWER SUPPORT</td> <td>1.000</td> <td>PC</td> </tr> <tr> <td>VM1621A0</td> <td>LED BAR UPPER SUPPORT</td> <td>1.000</td> <td>PC</td> </tr> </tbody> </table>	Code	Description	Qty	UOM	CE1455A0	TIP END FITTING	2.000	PC	CE1730A0	PVC CABLE NP 2 X AWG22 STYLE 2095	1.000	M	CE1735A0	MINIFIT FEMALE END FITTING	2.000	PC	CE1740A0	MINIFIT MALE END FITTING	2.000	PC	CE1745A0	2 WAYS FEMALE MINIFIT CONNECTOR	1.000	PC	CE1750A0	3 WAYS MALE MINIFIT CONNECTOR	1.000	PC	LP1002B0	LED LIGHTING BAR L400	1.000	PC	VM1620A0	LED BAR LOWER SUPPORT	1.000	PC	VM1621A0	LED BAR UPPER SUPPORT	1.000	PC
Code	Description	Qty	UOM																																							
CE1455A0	TIP END FITTING	2.000	PC																																							
CE1730A0	PVC CABLE NP 2 X AWG22 STYLE 2095	1.000	M																																							
CE1735A0	MINIFIT FEMALE END FITTING	2.000	PC																																							
CE1740A0	MINIFIT MALE END FITTING	2.000	PC																																							
CE1745A0	2 WAYS FEMALE MINIFIT CONNECTOR	1.000	PC																																							
CE1750A0	3 WAYS MALE MINIFIT CONNECTOR	1.000	PC																																							
LP1002B0	LED LIGHTING BAR L400	1.000	PC																																							
VM1620A0	LED BAR LOWER SUPPORT	1.000	PC																																							
VM1621A0	LED BAR UPPER SUPPORT	1.000	PC																																							
KLP1001B	L300 LED BAR KIT	<table border="1"> <thead> <tr> <th>Code</th> <th>Description</th> <th>Qty</th> <th>UOM</th> </tr> </thead> <tbody> <tr> <td>CE1455A0</td> <td>TIP END FITTING</td> <td>2.000</td> <td>PC</td> </tr> <tr> <td>CE1730A0</td> <td>PVC CABLE NP 2 X AWG22 STYLE 2095</td> <td>1.000</td> <td>M</td> </tr> <tr> <td>CE1735A0</td> <td>MINIFIT FEMALE END FITTING</td> <td>2.000</td> <td>PC</td> </tr> <tr> <td>CE1740A0</td> <td>MINIFIT MALE END FITTING</td> <td>2.000</td> <td>PC</td> </tr> <tr> <td>CE1745A0</td> <td>2 WAYS FEMALE MINIFIT CONNECTOR</td> <td>1.000</td> <td>PC</td> </tr> <tr> <td>CE1750A0</td> <td>3 WAYS MALE MINIFIT CONNECTOR</td> <td>1.000</td> <td>PC</td> </tr> <tr> <td>LP1001B0</td> <td>LED LIGHTING BAR L300</td> <td>1.000</td> <td>PC</td> </tr> <tr> <td>VM1620A0</td> <td>LED BAR LOWER SUPPORT</td> <td>1.000</td> <td>PC</td> </tr> <tr> <td>VM1621A0</td> <td>LED BAR UPPER SUPPORT</td> <td>1.000</td> <td>PC</td> </tr> </tbody> </table>	Code	Description	Qty	UOM	CE1455A0	TIP END FITTING	2.000	PC	CE1730A0	PVC CABLE NP 2 X AWG22 STYLE 2095	1.000	M	CE1735A0	MINIFIT FEMALE END FITTING	2.000	PC	CE1740A0	MINIFIT MALE END FITTING	2.000	PC	CE1745A0	2 WAYS FEMALE MINIFIT CONNECTOR	1.000	PC	CE1750A0	3 WAYS MALE MINIFIT CONNECTOR	1.000	PC	LP1001B0	LED LIGHTING BAR L300	1.000	PC	VM1620A0	LED BAR LOWER SUPPORT	1.000	PC	VM1621A0	LED BAR UPPER SUPPORT	1.000	PC
Code	Description	Qty	UOM																																							
CE1455A0	TIP END FITTING	2.000	PC																																							
CE1730A0	PVC CABLE NP 2 X AWG22 STYLE 2095	1.000	M																																							
CE1735A0	MINIFIT FEMALE END FITTING	2.000	PC																																							
CE1740A0	MINIFIT MALE END FITTING	2.000	PC																																							
CE1745A0	2 WAYS FEMALE MINIFIT CONNECTOR	1.000	PC																																							
CE1750A0	3 WAYS MALE MINIFIT CONNECTOR	1.000	PC																																							
LP1001B0	LED LIGHTING BAR L300	1.000	PC																																							
VM1620A0	LED BAR LOWER SUPPORT	1.000	PC																																							
VM1621A0	LED BAR UPPER SUPPORT	1.000	PC																																							



COMPONENT			SPARE PART																																										
Code	Description	Image	Code	Description	Kit components																																								
VM1620A	LED BAR LOWER SUPPORT		KLP1000A	L100 LED BAR KIT	<table border="1"> <thead> <tr> <th>Code</th> <th>Description</th> <th>Qty</th> <th>UOM</th> </tr> </thead> <tbody> <tr> <td>LP1000A0</td> <td>LED LIGHTING BAR L100</td> <td>1.000</td> <td>PC</td> </tr> <tr> <td>VM1620A0</td> <td>LED BAR LOWER SUPPORT</td> <td>1.000</td> <td>PC</td> </tr> <tr> <td>VM1621A0</td> <td>LED BAR UPPER SUPPORT</td> <td>1.000</td> <td>PC</td> </tr> </tbody> </table>	Code	Description	Qty	UOM	LP1000A0	LED LIGHTING BAR L100	1.000	PC	VM1620A0	LED BAR LOWER SUPPORT	1.000	PC	VM1621A0	LED BAR UPPER SUPPORT	1.000	PC																								
					Code	Description	Qty	UOM																																					
LP1000A0	LED LIGHTING BAR L100	1.000	PC																																										
VM1620A0	LED BAR LOWER SUPPORT	1.000	PC																																										
VM1621A0	LED BAR UPPER SUPPORT	1.000	PC																																										
VM1621A	LED BAR UPPER SUPPORT		KLP1044A	LUX LED BAR KIT	<table border="1"> <thead> <tr> <th>Code</th> <th>Description</th> <th>Qty</th> <th>UOM</th> </tr> </thead> <tbody> <tr> <td>CE1455A0</td> <td>TIP END FITTING</td> <td>2.000</td> <td>PC</td> </tr> <tr> <td>CE1730A0</td> <td>PVC CABLE NP 2 X AWG22 STYLE 2095</td> <td>1.000</td> <td>M</td> </tr> <tr> <td>CE1735A0</td> <td>MINIFIT FEMALE END FITTING</td> <td>2.000</td> <td>PC</td> </tr> <tr> <td>CE1740A0</td> <td>MINIFIT MALE END FITTING</td> <td>2.000</td> <td>PC</td> </tr> <tr> <td>CE1745A0</td> <td>2 WAYS FEMALE MINIFIT CONNECTOR</td> <td>1.000</td> <td>PC</td> </tr> <tr> <td>CE1750A0</td> <td>3 WAYS MALE MINIFIT CONNECTOR</td> <td>1.000</td> <td>PC</td> </tr> <tr> <td>LP1044A0</td> <td>LUX LED BAR</td> <td>1.000</td> <td>PC</td> </tr> <tr> <td>VM1620A0</td> <td>LED BAR LOWER SUPPORT</td> <td>1.000</td> <td>PC</td> </tr> <tr> <td>VM1621A0</td> <td>LED BAR UPPER SUPPORT</td> <td>1.000</td> <td>PC</td> </tr> </tbody> </table>	Code	Description	Qty	UOM	CE1455A0	TIP END FITTING	2.000	PC	CE1730A0	PVC CABLE NP 2 X AWG22 STYLE 2095	1.000	M	CE1735A0	MINIFIT FEMALE END FITTING	2.000	PC	CE1740A0	MINIFIT MALE END FITTING	2.000	PC	CE1745A0	2 WAYS FEMALE MINIFIT CONNECTOR	1.000	PC	CE1750A0	3 WAYS MALE MINIFIT CONNECTOR	1.000	PC	LP1044A0	LUX LED BAR	1.000	PC	VM1620A0	LED BAR LOWER SUPPORT	1.000	PC	VM1621A0	LED BAR UPPER SUPPORT	1.000	PC
					Code	Description	Qty	UOM																																					
					CE1455A0	TIP END FITTING	2.000	PC																																					
					CE1730A0	PVC CABLE NP 2 X AWG22 STYLE 2095	1.000	M																																					
					CE1735A0	MINIFIT FEMALE END FITTING	2.000	PC																																					
					CE1740A0	MINIFIT MALE END FITTING	2.000	PC																																					
					CE1745A0	2 WAYS FEMALE MINIFIT CONNECTOR	1.000	PC																																					
					CE1750A0	3 WAYS MALE MINIFIT CONNECTOR	1.000	PC																																					
					LP1044A0	LUX LED BAR	1.000	PC																																					
					VM1620A0	LED BAR LOWER SUPPORT	1.000	PC																																					
					VM1621A0	LED BAR UPPER SUPPORT	1.000	PC																																					
					KLP1007A	L200 LED BAR KIT	<table border="1"> <thead> <tr> <th>Code</th> <th>Description</th> <th>Qty</th> <th>UOM</th> </tr> </thead> <tbody> <tr> <td>CE1455A0</td> <td>TIP END FITTING</td> <td>2.000</td> <td>PC</td> </tr> <tr> <td>CE1730A0</td> <td>PVC CABLE NP 2 X AWG22 STYLE 2095</td> <td>1.000</td> <td>M</td> </tr> <tr> <td>CE1735A0</td> <td>MINIFIT FEMALE END FITTING</td> <td>2.000</td> <td>PC</td> </tr> <tr> <td>CE1740A0</td> <td>MINIFIT MALE END FITTING</td> <td>2.000</td> <td>PC</td> </tr> <tr> <td>CE1745A0</td> <td>2 WAYS FEMALE MINIFIT CONNECTOR</td> <td>1.000</td> <td>PC</td> </tr> <tr> <td>CE1750A0</td> <td>3 WAYS MALE MINIFIT CONNECTOR</td> <td>1.000</td> <td>PC</td> </tr> <tr> <td>LP1007A0</td> <td>LED LIGHT BAR L200</td> <td>1.000</td> <td>PC</td> </tr> </tbody> </table>	Code	Description	Qty	UOM	CE1455A0	TIP END FITTING	2.000	PC	CE1730A0	PVC CABLE NP 2 X AWG22 STYLE 2095	1.000	M	CE1735A0	MINIFIT FEMALE END FITTING	2.000	PC	CE1740A0	MINIFIT MALE END FITTING	2.000	PC	CE1745A0	2 WAYS FEMALE MINIFIT CONNECTOR	1.000	PC	CE1750A0	3 WAYS MALE MINIFIT CONNECTOR	1.000	PC	LP1007A0	LED LIGHT BAR L200	1.000	PC						
							Code	Description	Qty	UOM																																			
							CE1455A0	TIP END FITTING	2.000	PC																																			
CE1730A0	PVC CABLE NP 2 X AWG22 STYLE 2095	1.000	M																																										
CE1735A0	MINIFIT FEMALE END FITTING	2.000	PC																																										
CE1740A0	MINIFIT MALE END FITTING	2.000	PC																																										
CE1745A0	2 WAYS FEMALE MINIFIT CONNECTOR	1.000	PC																																										
CE1750A0	3 WAYS MALE MINIFIT CONNECTOR	1.000	PC																																										
LP1007A0	LED LIGHT BAR L200	1.000	PC																																										



COMPONENT			SPARE PART																																			
Code	Description	Image	Code	Description	Kit components																																	
VM1621A	LED BAR UPPER SUPPORT		KLP1007A	L200 LED BAR KIT	<table border="1"> <thead> <tr> <th>Code</th> <th>Description</th> <th>Qty</th> <th>UOM</th> </tr> </thead> <tbody> <tr> <td>VM1620A0</td> <td>LED BAR LOWER SUPPORT</td> <td>1.000</td> <td>PC</td> </tr> <tr> <td>VM1621A0</td> <td>LED BAR UPPER SUPPORT</td> <td>1.000</td> <td>PC</td> </tr> </tbody> </table>	Code	Description	Qty	UOM	VM1620A0	LED BAR LOWER SUPPORT	1.000	PC	VM1621A0	LED BAR UPPER SUPPORT	1.000	PC																					
			Code	Description	Qty	UOM																																
			VM1620A0	LED BAR LOWER SUPPORT	1.000	PC																																
VM1621A0	LED BAR UPPER SUPPORT	1.000	PC																																			
KLP1004B	L1000 LED BAR KIT	<table border="1"> <thead> <tr> <th>Code</th> <th>Description</th> <th>Qty</th> <th>UOM</th> </tr> </thead> <tbody> <tr> <td>CE1730A0</td> <td>PVC CABLE NP 2 X AWG22 STYLE 2095</td> <td>1.000</td> <td>M</td> </tr> <tr> <td>CE1735A0</td> <td>MINIFIT FEMALE END FITTING</td> <td>2.000</td> <td>PC</td> </tr> <tr> <td>CE1740A0</td> <td>MINIFIT MALE END FITTING</td> <td>2.000</td> <td>PC</td> </tr> <tr> <td>CE1745A0</td> <td>2 WAYS FEMALE MINIFIT CONNECTOR</td> <td>1.000</td> <td>PC</td> </tr> <tr> <td>CE1750A0</td> <td>3 WAYS MALE MINIFIT CONNECTOR</td> <td>1.000</td> <td>PC</td> </tr> <tr> <td>LP1004B0</td> <td>LEB LIGHTING BAR L1000</td> <td>1.000</td> <td>PC</td> </tr> <tr> <td>VM1620A0</td> <td>LED BAR LOWER SUPPORT</td> <td>1.000</td> <td>PC</td> </tr> <tr> <td>VM1621A0</td> <td>LED BAR UPPER SUPPORT</td> <td>1.000</td> <td>PC</td> </tr> </tbody> </table>	Code	Description	Qty	UOM	CE1730A0	PVC CABLE NP 2 X AWG22 STYLE 2095	1.000	M	CE1735A0	MINIFIT FEMALE END FITTING	2.000	PC	CE1740A0	MINIFIT MALE END FITTING	2.000	PC	CE1745A0	2 WAYS FEMALE MINIFIT CONNECTOR	1.000	PC	CE1750A0	3 WAYS MALE MINIFIT CONNECTOR	1.000	PC	LP1004B0	LEB LIGHTING BAR L1000	1.000	PC	VM1620A0	LED BAR LOWER SUPPORT	1.000	PC	VM1621A0	LED BAR UPPER SUPPORT	1.000	PC
Code	Description	Qty	UOM																																			
CE1730A0	PVC CABLE NP 2 X AWG22 STYLE 2095	1.000	M																																			
CE1735A0	MINIFIT FEMALE END FITTING	2.000	PC																																			
CE1740A0	MINIFIT MALE END FITTING	2.000	PC																																			
CE1745A0	2 WAYS FEMALE MINIFIT CONNECTOR	1.000	PC																																			
CE1750A0	3 WAYS MALE MINIFIT CONNECTOR	1.000	PC																																			
LP1004B0	LEB LIGHTING BAR L1000	1.000	PC																																			
VM1620A0	LED BAR LOWER SUPPORT	1.000	PC																																			
VM1621A0	LED BAR UPPER SUPPORT	1.000	PC																																			
KLP1003B	2017 LED BAR KIT	<table border="1"> <thead> <tr> <th>Code</th> <th>Description</th> <th>Qty</th> <th>UOM</th> </tr> </thead> <tbody> <tr> <td>CE1730A0</td> <td>PVC CABLE NP 2 X AWG22 STYLE 2095</td> <td>1.000</td> <td>M</td> </tr> <tr> <td>CE1735A0</td> <td>MINIFIT FEMALE END FITTING</td> <td>2.000</td> <td>PC</td> </tr> <tr> <td>CE1740A0</td> <td>MINIFIT MALE END FITTING</td> <td>2.000</td> <td>PC</td> </tr> <tr> <td>CE1745A0</td> <td>2 WAYS FEMALE MINIFIT CONNECTOR</td> <td>1.000</td> <td>PC</td> </tr> <tr> <td>CE1750A0</td> <td>3 WAYS MALE MINIFIT CONNECTOR</td> <td>1.000</td> <td>PC</td> </tr> <tr> <td>LP1003B0</td> <td>LED LIGHT BAR L600</td> <td>1.000</td> <td>PC</td> </tr> <tr> <td>VM1620A0</td> <td>LED BAR LOWER SUPPORT</td> <td>1.000</td> <td>PC</td> </tr> <tr> <td>VM1621A0</td> <td>LED BAR UPPER SUPPORT</td> <td>1.000</td> <td>PC</td> </tr> </tbody> </table>	Code	Description	Qty	UOM	CE1730A0	PVC CABLE NP 2 X AWG22 STYLE 2095	1.000	M	CE1735A0	MINIFIT FEMALE END FITTING	2.000	PC	CE1740A0	MINIFIT MALE END FITTING	2.000	PC	CE1745A0	2 WAYS FEMALE MINIFIT CONNECTOR	1.000	PC	CE1750A0	3 WAYS MALE MINIFIT CONNECTOR	1.000	PC	LP1003B0	LED LIGHT BAR L600	1.000	PC	VM1620A0	LED BAR LOWER SUPPORT	1.000	PC	VM1621A0	LED BAR UPPER SUPPORT	1.000	PC
Code	Description	Qty	UOM																																			
CE1730A0	PVC CABLE NP 2 X AWG22 STYLE 2095	1.000	M																																			
CE1735A0	MINIFIT FEMALE END FITTING	2.000	PC																																			
CE1740A0	MINIFIT MALE END FITTING	2.000	PC																																			
CE1745A0	2 WAYS FEMALE MINIFIT CONNECTOR	1.000	PC																																			
CE1750A0	3 WAYS MALE MINIFIT CONNECTOR	1.000	PC																																			
LP1003B0	LED LIGHT BAR L600	1.000	PC																																			
VM1620A0	LED BAR LOWER SUPPORT	1.000	PC																																			
VM1621A0	LED BAR UPPER SUPPORT	1.000	PC																																			



COMPONENT			SPARE PART																																							
Code	Description	Image	Code	Description	Kit components																																					
VM1621A	LED BAR UPPER SUPPORT		KLP1003B	2017 LED BAR KIT	<table border="1"> <thead> <tr> <th>Code</th> <th>Description</th> <th>Qty</th> <th>UOM</th> </tr> </thead> <tbody> <tr> <td>VM1794A0</td> <td>250x4.8 PA66 BLACK CLAMP</td> <td>2.000</td> <td>PC</td> </tr> <tr> <td>VM2103A0</td> <td>CLAMP LOCK</td> <td>2.000</td> <td>PC</td> </tr> </tbody> </table>	Code	Description	Qty	UOM	VM1794A0	250x4.8 PA66 BLACK CLAMP	2.000	PC	VM2103A0	CLAMP LOCK	2.000	PC																									
			Code	Description	Qty	UOM																																				
			VM1794A0	250x4.8 PA66 BLACK CLAMP	2.000	PC																																				
VM2103A0	CLAMP LOCK	2.000	PC																																							
KLP1002B	L400 LED BAR KIT	<table border="1"> <thead> <tr> <th>Code</th> <th>Description</th> <th>Qty</th> <th>UOM</th> </tr> </thead> <tbody> <tr> <td>CE1455A0</td> <td>TIP END FITTING</td> <td>2.000</td> <td>PC</td> </tr> <tr> <td>CE1730A0</td> <td>PVC CABLE NP 2 X AWG22 STYLE 2095</td> <td>1.000</td> <td>M</td> </tr> <tr> <td>CE1735A0</td> <td>MINIFIT FEMALE END FITTING</td> <td>2.000</td> <td>PC</td> </tr> <tr> <td>CE1740A0</td> <td>MINIFIT MALE END FITTING</td> <td>2.000</td> <td>PC</td> </tr> <tr> <td>CE1745A0</td> <td>2 WAYS FEMALE MINIFIT CONNECTOR</td> <td>1.000</td> <td>PC</td> </tr> <tr> <td>CE1750A0</td> <td>3 WAYS MALE MINIFIT CONNECTOR</td> <td>1.000</td> <td>PC</td> </tr> <tr> <td>LP1002B0</td> <td>LED LIGHTING BAR L400</td> <td>1.000</td> <td>PC</td> </tr> <tr> <td>VM1620A0</td> <td>LED BAR LOWER SUPPORT</td> <td>1.000</td> <td>PC</td> </tr> <tr> <td>VM1621A0</td> <td>LED BAR UPPER SUPPORT</td> <td>1.000</td> <td>PC</td> </tr> </tbody> </table>	Code	Description	Qty	UOM	CE1455A0	TIP END FITTING	2.000	PC	CE1730A0	PVC CABLE NP 2 X AWG22 STYLE 2095	1.000	M	CE1735A0	MINIFIT FEMALE END FITTING	2.000	PC	CE1740A0	MINIFIT MALE END FITTING	2.000	PC	CE1745A0	2 WAYS FEMALE MINIFIT CONNECTOR	1.000	PC	CE1750A0	3 WAYS MALE MINIFIT CONNECTOR	1.000	PC	LP1002B0	LED LIGHTING BAR L400	1.000	PC	VM1620A0	LED BAR LOWER SUPPORT	1.000	PC	VM1621A0	LED BAR UPPER SUPPORT	1.000	PC
Code	Description	Qty	UOM																																							
CE1455A0	TIP END FITTING	2.000	PC																																							
CE1730A0	PVC CABLE NP 2 X AWG22 STYLE 2095	1.000	M																																							
CE1735A0	MINIFIT FEMALE END FITTING	2.000	PC																																							
CE1740A0	MINIFIT MALE END FITTING	2.000	PC																																							
CE1745A0	2 WAYS FEMALE MINIFIT CONNECTOR	1.000	PC																																							
CE1750A0	3 WAYS MALE MINIFIT CONNECTOR	1.000	PC																																							
LP1002B0	LED LIGHTING BAR L400	1.000	PC																																							
VM1620A0	LED BAR LOWER SUPPORT	1.000	PC																																							
VM1621A0	LED BAR UPPER SUPPORT	1.000	PC																																							
KLP1001B	L300 LED BAR KIT	<table border="1"> <thead> <tr> <th>Code</th> <th>Description</th> <th>Qty</th> <th>UOM</th> </tr> </thead> <tbody> <tr> <td>CE1455A0</td> <td>TIP END FITTING</td> <td>2.000</td> <td>PC</td> </tr> <tr> <td>CE1730A0</td> <td>PVC CABLE NP 2 X AWG22 STYLE 2095</td> <td>1.000</td> <td>M</td> </tr> <tr> <td>CE1735A0</td> <td>MINIFIT FEMALE END FITTING</td> <td>2.000</td> <td>PC</td> </tr> <tr> <td>CE1740A0</td> <td>MINIFIT MALE END FITTING</td> <td>2.000</td> <td>PC</td> </tr> <tr> <td>CE1745A0</td> <td>2 WAYS FEMALE MINIFIT CONNECTOR</td> <td>1.000</td> <td>PC</td> </tr> <tr> <td>CE1750A0</td> <td>3 WAYS MALE MINIFIT CONNECTOR</td> <td>1.000</td> <td>PC</td> </tr> <tr> <td>LP1001B0</td> <td>LED LIGHTING BAR L300</td> <td>1.000</td> <td>PC</td> </tr> <tr> <td>VM1620A0</td> <td>LED BAR LOWER SUPPORT</td> <td>1.000</td> <td>PC</td> </tr> <tr> <td>VM1621A0</td> <td>LED BAR UPPER SUPPORT</td> <td>1.000</td> <td>PC</td> </tr> </tbody> </table>	Code	Description	Qty	UOM	CE1455A0	TIP END FITTING	2.000	PC	CE1730A0	PVC CABLE NP 2 X AWG22 STYLE 2095	1.000	M	CE1735A0	MINIFIT FEMALE END FITTING	2.000	PC	CE1740A0	MINIFIT MALE END FITTING	2.000	PC	CE1745A0	2 WAYS FEMALE MINIFIT CONNECTOR	1.000	PC	CE1750A0	3 WAYS MALE MINIFIT CONNECTOR	1.000	PC	LP1001B0	LED LIGHTING BAR L300	1.000	PC	VM1620A0	LED BAR LOWER SUPPORT	1.000	PC	VM1621A0	LED BAR UPPER SUPPORT	1.000	PC
Code	Description	Qty	UOM																																							
CE1455A0	TIP END FITTING	2.000	PC																																							
CE1730A0	PVC CABLE NP 2 X AWG22 STYLE 2095	1.000	M																																							
CE1735A0	MINIFIT FEMALE END FITTING	2.000	PC																																							
CE1740A0	MINIFIT MALE END FITTING	2.000	PC																																							
CE1745A0	2 WAYS FEMALE MINIFIT CONNECTOR	1.000	PC																																							
CE1750A0	3 WAYS MALE MINIFIT CONNECTOR	1.000	PC																																							
LP1001B0	LED LIGHTING BAR L300	1.000	PC																																							
VM1620A0	LED BAR LOWER SUPPORT	1.000	PC																																							
VM1621A0	LED BAR UPPER SUPPORT	1.000	PC																																							

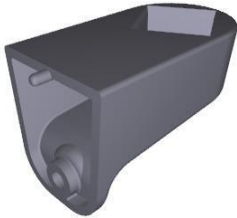
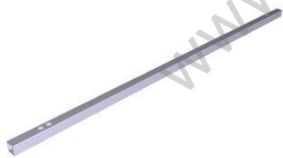

COMPONENT			SPARE PART																		
Code	Description	Image	Code	Description	Kit components																
VM1621A	LED BAR UPPER SUPPORT		KLP1000A	L100 LED BAR KIT	<table border="1"> <thead> <tr> <th>Code</th> <th>Description</th> <th>Qty</th> <th>UOM</th> </tr> </thead> <tbody> <tr> <td>LP1000A0</td> <td>LED LIGHTING BAR L100</td> <td>1.000</td> <td>PC</td> </tr> <tr> <td>VM1620A0</td> <td>LED BAR LOWER SUPPORT</td> <td>1.000</td> <td>PC</td> </tr> <tr> <td>VM1621A0</td> <td>LED BAR UPPER SUPPORT</td> <td>1.000</td> <td>PC</td> </tr> </tbody> </table>	Code	Description	Qty	UOM	LP1000A0	LED LIGHTING BAR L100	1.000	PC	VM1620A0	LED BAR LOWER SUPPORT	1.000	PC	VM1621A0	LED BAR UPPER SUPPORT	1.000	PC
					Code	Description	Qty	UOM													
					LP1000A0	LED LIGHTING BAR L100	1.000	PC													
					VM1620A0	LED BAR LOWER SUPPORT	1.000	PC													
VM1621A0	LED BAR UPPER SUPPORT	1.000	PC																		
MG1030B	CT-BT DOOR HANDL		KMG1030B	CT-BT-CLUX-BLUX HANDLE KIT	<table border="1"> <thead> <tr> <th>Code</th> <th>Description</th> <th>Qty</th> <th>UOM</th> </tr> </thead> <tbody> <tr> <td>MG1030B2</td> <td>CT-BT DOOR HANDLE</td> <td>1.000</td> <td>PC</td> </tr> <tr> <td>VI0239A1</td> <td>SELF-TAPPIN G SCREW 4.2X25 TCB+ INOX</td> <td>4.000</td> <td>PC</td> </tr> <tr> <td>VM1490A0</td> <td>CHEFTOP/BAK ERTOP HANDLE SCREWS COVER</td> <td>2.000</td> <td>PC</td> </tr> </tbody> </table>	Code	Description	Qty	UOM	MG1030B2	CT-BT DOOR HANDLE	1.000	PC	VI0239A1	SELF-TAPPIN G SCREW 4.2X25 TCB+ INOX	4.000	PC	VM1490A0	CHEFTOP/BAK ERTOP HANDLE SCREWS COVER	2.000	PC
					Code	Description	Qty	UOM													
					MG1030B2	CT-BT DOOR HANDLE	1.000	PC													
VI0239A1	SELF-TAPPIN G SCREW 4.2X25 TCB+ INOX	4.000	PC																		
VM1490A0	CHEFTOP/BAK ERTOP HANDLE SCREWS COVER	2.000	PC																		
TB2384B	BAKERLUX CHEFLUX DOOR UPPER LISTEL		TB2384B0	BAKERLUX CHEFLUX DOOR UPPER LISTEL																	
					TB2404A	BAKERLUX CHEFLUX DOOR LOWER LISTEL		TB2404A0	BAKERLUX CHEFLUX DOOR LOWER LISTEL												
TB3092A	6TRAY BAKERTOP LEFT DOOR COLUM		TB3092A0	6TRAY BAKERTOP LEFT DOOR COLUM																	



COMPONENT			SPARE PART														
Code	Description	Image	Code	Description	Kit components												
TB3096A	6TRAY BAKERTOP RIGHT DOOR COLUMN		TB3096A0	6TRAY BAKERTOP RIGHT DOOR COLUMN													
VM1510A	XBC/XVC GROOVED DOOR PIN BUSHING		KVM1510A	GROOVED DOOR PIN BUSHING 5 PCS KIT	<table border="1"> <thead> <tr> <th>Code</th> <th>Description</th> <th>Qty</th> <th>UOM</th> </tr> </thead> <tbody> <tr> <td>VM1510A0</td> <td>XBC/XVC GROOVED DOOR PIN BUSHING</td> <td>5.000</td> <td>PC</td> </tr> </tbody> </table>	Code	Description	Qty	UOM	VM1510A0	XBC/XVC GROOVED DOOR PIN BUSHING	5.000	PC				
Code	Description	Qty	UOM														
VM1510A0	XBC/XVC GROOVED DOOR PIN BUSHING	5.000	PC														
VM1511A	XBC/XVC SLEEK DOOR PIN BUSHING		KVM1511A	5 PCS SLEEK DOOR PIN BUSHING KIT	<table border="1"> <thead> <tr> <th>Code</th> <th>Description</th> <th>Qty</th> <th>UOM</th> </tr> </thead> <tbody> <tr> <td>VM1511A0</td> <td>XBC/XVC SLEEK DOOR PIN BUSHING</td> <td>5.000</td> <td>PC</td> </tr> </tbody> </table>	Code	Description	Qty	UOM	VM1511A0	XBC/XVC SLEEK DOOR PIN BUSHING	5.000	PC				
Code	Description	Qty	UOM														
VM1511A0	XBC/XVC SLEEK DOOR PIN BUSHING	5.000	PC														
VM1680A	INTERNAL GLASS HINGE		KVM1680A	INTERNAL GLASS HINGE SUPPORT 2 PCS KIT	<table border="1"> <thead> <tr> <th>Code</th> <th>Description</th> <th>Qty</th> <th>UOM</th> </tr> </thead> <tbody> <tr> <td>V11300A0</td> <td>SCREW M6X12 T1/2T+INOX</td> <td>4.000</td> <td>PC</td> </tr> <tr> <td>VM1680A0</td> <td>INTERNAL GLASS HINGE</td> <td>2.000</td> <td>PC</td> </tr> </tbody> </table>	Code	Description	Qty	UOM	V11300A0	SCREW M6X12 T1/2T+INOX	4.000	PC	VM1680A0	INTERNAL GLASS HINGE	2.000	PC
Code	Description	Qty	UOM														
V11300A0	SCREW M6X12 T1/2T+INOX	4.000	PC														
VM1680A0	INTERNAL GLASS HINGE	2.000	PC														
VM1976A	CL BL DOOR COLUMN BLANKING CAP		KVM1976A	CL BL DOOR COLUMN BLANKING CAP KIT	<table border="1"> <thead> <tr> <th>Code</th> <th>Description</th> <th>Qty</th> <th>UOM</th> </tr> </thead> <tbody> <tr> <td>VM1976A0</td> <td>CL BL DOOR COLUMN BLANKING CA</td> <td>1.000</td> <td>PC</td> </tr> </tbody> </table>	Code	Description	Qty	UOM	VM1976A0	CL BL DOOR COLUMN BLANKING CA	1.000	PC				
Code	Description	Qty	UOM														
VM1976A0	CL BL DOOR COLUMN BLANKING CA	1.000	PC														

COMPONENT			SPARE PART																																																										
Code	Description	Image	Code	Description	Kit components																																																								
VM1977A	CL BL DOOR UPPER FULCRUM-CAP		KVM1977A	CL BL DOOR UPPER FULCRUM-CAP KIT	<table border="1"> <thead> <tr> <th>Code</th> <th>Description</th> <th>Qty</th> <th>UOM</th> </tr> </thead> <tbody> <tr> <td>VM1977A0</td> <td>CL BL DOOR UPPER FULCRUM-CA</td> <td>1.000</td> <td>PC</td> </tr> </tbody> </table>	Code	Description	Qty	UOM	VM1977A0	CL BL DOOR UPPER FULCRUM-CA	1.000	PC																																																
Code	Description	Qty	UOM																																																										
VM1977A0	CL BL DOOR UPPER FULCRUM-CA	1.000	PC																																																										
VM1978A	CL BL DOOR LOWER FULCRUM-CAP		KDR1254A	XB893 XV893 COMPLETE DOOR	<table border="1"> <thead> <tr> <th>Code</th> <th>Description</th> <th>Qty</th> <th>UOM</th> </tr> </thead> <tbody> <tr> <td>0H6575A1</td> <td>XB89- XV EXTERNAL GLASS HOLDING PROFILE</td> <td>2.000</td> <td>PC</td> </tr> <tr> <td>CR1085A0</td> <td>INTERNAL GLASS UPPER HINGE</td> <td>1.000</td> <td>PC</td> </tr> <tr> <td>CR1086A0</td> <td>INTERNAL GLASS LOWER HINGE</td> <td>1.000</td> <td>PC</td> </tr> <tr> <td>GN1181A0</td> <td>INTERNAL GLASS HINGE SEAL</td> <td>2.000</td> <td>PC</td> </tr> <tr> <td>MG1030B2</td> <td>CT-BT DOOR HANDLE</td> <td>1.000</td> <td>PC</td> </tr> <tr> <td>SL1110A0</td> <td>BIADHESIVE PIN 3M VHB 9473-PC</td> <td>1.000</td> <td>PC</td> </tr> <tr> <td>TB2384B0</td> <td>BAKERLUX CHEFLUX DOOR UPPER LISTEL</td> <td>1.000</td> <td>PC</td> </tr> <tr> <td>TB2385A0</td> <td>BL CL 89- RIGHT DOOR COLUMN 50x50x1.2</td> <td>1.000</td> <td>PC</td> </tr> <tr> <td>TB2386A0</td> <td>BL CL 89- LEFT DOOR COLUMN 50x50x1.2</td> <td>1.000</td> <td>PC</td> </tr> <tr> <td>TB2404A0</td> <td>BAKERLUX CHEFLUX DOOR LOWER LISTEL</td> <td>1.000</td> <td>PC</td> </tr> <tr> <td>VI0239A1</td> <td>SELF-TAPPIN G SCREW 4.2X25 TCB+ INOX</td> <td>4.000</td> <td>PC</td> </tr> <tr> <td>VI1070A0</td> <td>SCREW M4x16 TSP/UNI7688 INOX</td> <td>1.000</td> <td>PC</td> </tr> <tr> <td>VI1075A0</td> <td>NUT M4 H=4 UNI5587 INOX</td> <td>1.000</td> <td>PC</td> </tr> </tbody> </table>	Code	Description	Qty	UOM	0H6575A1	XB89- XV EXTERNAL GLASS HOLDING PROFILE	2.000	PC	CR1085A0	INTERNAL GLASS UPPER HINGE	1.000	PC	CR1086A0	INTERNAL GLASS LOWER HINGE	1.000	PC	GN1181A0	INTERNAL GLASS HINGE SEAL	2.000	PC	MG1030B2	CT-BT DOOR HANDLE	1.000	PC	SL1110A0	BIADHESIVE PIN 3M VHB 9473-PC	1.000	PC	TB2384B0	BAKERLUX CHEFLUX DOOR UPPER LISTEL	1.000	PC	TB2385A0	BL CL 89- RIGHT DOOR COLUMN 50x50x1.2	1.000	PC	TB2386A0	BL CL 89- LEFT DOOR COLUMN 50x50x1.2	1.000	PC	TB2404A0	BAKERLUX CHEFLUX DOOR LOWER LISTEL	1.000	PC	VI0239A1	SELF-TAPPIN G SCREW 4.2X25 TCB+ INOX	4.000	PC	VI1070A0	SCREW M4x16 TSP/UNI7688 INOX	1.000	PC	VI1075A0	NUT M4 H=4 UNI5587 INOX	1.000	PC
Code	Description	Qty	UOM																																																										
0H6575A1	XB89- XV EXTERNAL GLASS HOLDING PROFILE	2.000	PC																																																										
CR1085A0	INTERNAL GLASS UPPER HINGE	1.000	PC																																																										
CR1086A0	INTERNAL GLASS LOWER HINGE	1.000	PC																																																										
GN1181A0	INTERNAL GLASS HINGE SEAL	2.000	PC																																																										
MG1030B2	CT-BT DOOR HANDLE	1.000	PC																																																										
SL1110A0	BIADHESIVE PIN 3M VHB 9473-PC	1.000	PC																																																										
TB2384B0	BAKERLUX CHEFLUX DOOR UPPER LISTEL	1.000	PC																																																										
TB2385A0	BL CL 89- RIGHT DOOR COLUMN 50x50x1.2	1.000	PC																																																										
TB2386A0	BL CL 89- LEFT DOOR COLUMN 50x50x1.2	1.000	PC																																																										
TB2404A0	BAKERLUX CHEFLUX DOOR LOWER LISTEL	1.000	PC																																																										
VI0239A1	SELF-TAPPIN G SCREW 4.2X25 TCB+ INOX	4.000	PC																																																										
VI1070A0	SCREW M4x16 TSP/UNI7688 INOX	1.000	PC																																																										
VI1075A0	NUT M4 H=4 UNI5587 INOX	1.000	PC																																																										



COMPONENT			SPARE PART																																																																										
Code	Description	Image	Code	Description	Kit components																																																																								
VM1978A	CL BL DOOR LOWER FULCRUM-CAP		KDR1254A	XB893 XV893 COMPLETE DOOR	<table border="1"> <thead> <tr> <th>Code</th> <th>Description</th> <th>Qty</th> <th>UOM</th> </tr> </thead> <tbody> <tr> <td>VI1220A1</td> <td>4,2x12 TCB SELF-TAPPIN G SCREW</td> <td>28.000</td> <td>PC</td> </tr> <tr> <td>VI1300A0</td> <td>SCREW M6X12 T1/2T+INOX</td> <td>12.000</td> <td>PC</td> </tr> <tr> <td>VI1310A0</td> <td>ZINC THREAD INSERT M6 FTR/E</td> <td>8.000</td> <td>PC</td> </tr> <tr> <td>VI1340A0</td> <td>M6 ST. STEEL THREADED INSERT</td> <td>4.000</td> <td>PC</td> </tr> <tr> <td>VI1810A0</td> <td>M6X6 STAINLESS STEEL FLATHEAD SCREW</td> <td>6.000</td> <td>PC</td> </tr> <tr> <td>VM1490A0</td> <td>CHEFTOP/BAK ERTOP HANDLE SCREWS COVER</td> <td>2.000</td> <td>PC</td> </tr> <tr> <td>VM1510A0</td> <td>XBC/XVC GROOVED DOOR PIN BUSHING</td> <td>1.000</td> <td>PC</td> </tr> <tr> <td>VM1511A0</td> <td>XBC/XVC SLEEK DOOR PIN BUSHING</td> <td>1.000</td> <td>PC</td> </tr> <tr> <td>VM1591A0</td> <td>GLASS BRACKET INT. XVC1004</td> <td>1.000</td> <td>PC</td> </tr> <tr> <td>VM1630A1</td> <td>INTERNAL GLASS PUSHING CAP</td> <td>2.000</td> <td>PC</td> </tr> <tr> <td>VM1680A0</td> <td>INTERNAL GLASS HINGE</td> <td>2.000</td> <td>PC</td> </tr> <tr> <td>VM1976A0</td> <td>CL BL DOOR COLUMN BLANKING CA</td> <td>2.000</td> <td>PC</td> </tr> <tr> <td>VM1977A0</td> <td>CL BL DOOR UPPER FULCRUM-CA</td> <td>1.000</td> <td>PC</td> </tr> <tr> <td>VM1978A0</td> <td>CL BL DOOR LOWER FULCRUM-CA</td> <td>1.000</td> <td>PC</td> </tr> <tr> <td>VM2000A0</td> <td>M4 SOCKET HEAD SCREW COVER</td> <td>6.000</td> <td>PC</td> </tr> <tr> <td>VM2008A0</td> <td>SPACER FOR MICROSWITC</td> <td>1.000</td> <td>PC</td> </tr> <tr> <td>VM2042A0</td> <td>INTERNAL GLASS LATERAL LOCKING SYSTEM</td> <td>2.000</td> <td>PC</td> </tr> </tbody> </table>	Code	Description	Qty	UOM	VI1220A1	4,2x12 TCB SELF-TAPPIN G SCREW	28.000	PC	VI1300A0	SCREW M6X12 T1/2T+INOX	12.000	PC	VI1310A0	ZINC THREAD INSERT M6 FTR/E	8.000	PC	VI1340A0	M6 ST. STEEL THREADED INSERT	4.000	PC	VI1810A0	M6X6 STAINLESS STEEL FLATHEAD SCREW	6.000	PC	VM1490A0	CHEFTOP/BAK ERTOP HANDLE SCREWS COVER	2.000	PC	VM1510A0	XBC/XVC GROOVED DOOR PIN BUSHING	1.000	PC	VM1511A0	XBC/XVC SLEEK DOOR PIN BUSHING	1.000	PC	VM1591A0	GLASS BRACKET INT. XVC1004	1.000	PC	VM1630A1	INTERNAL GLASS PUSHING CAP	2.000	PC	VM1680A0	INTERNAL GLASS HINGE	2.000	PC	VM1976A0	CL BL DOOR COLUMN BLANKING CA	2.000	PC	VM1977A0	CL BL DOOR UPPER FULCRUM-CA	1.000	PC	VM1978A0	CL BL DOOR LOWER FULCRUM-CA	1.000	PC	VM2000A0	M4 SOCKET HEAD SCREW COVER	6.000	PC	VM2008A0	SPACER FOR MICROSWITC	1.000	PC	VM2042A0	INTERNAL GLASS LATERAL LOCKING SYSTEM	2.000	PC
Code	Description	Qty	UOM																																																																										
VI1220A1	4,2x12 TCB SELF-TAPPIN G SCREW	28.000	PC																																																																										
VI1300A0	SCREW M6X12 T1/2T+INOX	12.000	PC																																																																										
VI1310A0	ZINC THREAD INSERT M6 FTR/E	8.000	PC																																																																										
VI1340A0	M6 ST. STEEL THREADED INSERT	4.000	PC																																																																										
VI1810A0	M6X6 STAINLESS STEEL FLATHEAD SCREW	6.000	PC																																																																										
VM1490A0	CHEFTOP/BAK ERTOP HANDLE SCREWS COVER	2.000	PC																																																																										
VM1510A0	XBC/XVC GROOVED DOOR PIN BUSHING	1.000	PC																																																																										
VM1511A0	XBC/XVC SLEEK DOOR PIN BUSHING	1.000	PC																																																																										
VM1591A0	GLASS BRACKET INT. XVC1004	1.000	PC																																																																										
VM1630A1	INTERNAL GLASS PUSHING CAP	2.000	PC																																																																										
VM1680A0	INTERNAL GLASS HINGE	2.000	PC																																																																										
VM1976A0	CL BL DOOR COLUMN BLANKING CA	2.000	PC																																																																										
VM1977A0	CL BL DOOR UPPER FULCRUM-CA	1.000	PC																																																																										
VM1978A0	CL BL DOOR LOWER FULCRUM-CA	1.000	PC																																																																										
VM2000A0	M4 SOCKET HEAD SCREW COVER	6.000	PC																																																																										
VM2008A0	SPACER FOR MICROSWITC	1.000	PC																																																																										
VM2042A0	INTERNAL GLASS LATERAL LOCKING SYSTEM	2.000	PC																																																																										



PLATON SERVICE
8 (800) 500-34-47
www.platonservice.com

COMPONENT			SPARE PART																						
Code	Description	Image	Code	Description	Kit components																				
VM1978A	CL BL DOOR LOWER FULCRUM-CAP		KDR1254A	XB893 XV893 COMPLETE DOOR	<table border="1"> <thead> <tr> <th>Code</th> <th>Description</th> <th>Qty</th> <th>UOM</th> </tr> </thead> <tbody> <tr> <td>VM2043A0</td> <td>UPPER - LOWER GLASS SUPPORT</td> <td>2.000</td> <td>PC</td> </tr> <tr> <td>VT1140A0</td> <td>XB893/895 XBC804/805 INTERNAL GLASS</td> <td>1.000</td> <td>PC</td> </tr> <tr> <td>VT1254A0</td> <td>OUTER GLASS XB89- XC89-</td> <td>1.000</td> <td>PC</td> </tr> </tbody> </table>	Code	Description	Qty	UOM	VM2043A0	UPPER - LOWER GLASS SUPPORT	2.000	PC	VT1140A0	XB893/895 XBC804/805 INTERNAL GLASS	1.000	PC	VT1254A0	OUTER GLASS XB89- XC89-	1.000	PC				
Code	Description	Qty	UOM																						
VM2043A0	UPPER - LOWER GLASS SUPPORT	2.000	PC																						
VT1140A0	XB893/895 XBC804/805 INTERNAL GLASS	1.000	PC																						
VT1254A0	OUTER GLASS XB89- XC89-	1.000	PC																						
VM2042A	INTERNAL GLASS LATERAL LOCKING SYSTEM		KVM2042A	INTERNAL GLASS SPRING STOPPER KIT	<table border="1"> <thead> <tr> <th>Code</th> <th>Description</th> <th>Qty</th> <th>UOM</th> </tr> </thead> <tbody> <tr> <td>RC1200A0</td> <td>ED=4 WIRE D.=0.5 COMPRESSIO N SPRING</td> <td>2.000</td> <td>PC</td> </tr> <tr> <td>VI1220A1</td> <td>4,2x12 TCB SELF-TAPPIN G SCREW</td> <td>2.000</td> <td>PC</td> </tr> <tr> <td>VM2042A0</td> <td>INTERNAL GLASS LATERAL LOCKING SYSTEM</td> <td>1.000</td> <td>PC</td> </tr> </tbody> </table>	Code	Description	Qty	UOM	RC1200A0	ED=4 WIRE D.=0.5 COMPRESSIO N SPRING	2.000	PC	VI1220A1	4,2x12 TCB SELF-TAPPIN G SCREW	2.000	PC	VM2042A0	INTERNAL GLASS LATERAL LOCKING SYSTEM	1.000	PC				
Code	Description	Qty	UOM																						
RC1200A0	ED=4 WIRE D.=0.5 COMPRESSIO N SPRING	2.000	PC																						
VI1220A1	4,2x12 TCB SELF-TAPPIN G SCREW	2.000	PC																						
VM2042A0	INTERNAL GLASS LATERAL LOCKING SYSTEM	1.000	PC																						
VM2043A	UPPER - LOWER GLASS SUPPORT		KVM2043A	UPPER - LOWER GLASS SUPPORT 2 PCS KIT	<table border="1"> <thead> <tr> <th>Code</th> <th>Description</th> <th>Qty</th> <th>UOM</th> </tr> </thead> <tbody> <tr> <td>VM2043A0</td> <td>UPPER - LOWER GLASS SUPPORT</td> <td>2.000</td> <td>PC</td> </tr> </tbody> </table>	Code	Description	Qty	UOM	VM2043A0	UPPER - LOWER GLASS SUPPORT	2.000	PC												
Code	Description	Qty	UOM																						
VM2043A0	UPPER - LOWER GLASS SUPPORT	2.000	PC																						
VT1255A	XB69- XC59- EXTERNAL GLASS		<p>KVT1255AR</p> <p>KVT1255A</p>	<p>XB69-XV593 LED EXTERNAL GLASS KIT</p> <p>XB69- XV593 EXTERNAL GLASS KIT</p>	<table border="1"> <thead> <tr> <th>Code</th> <th>Description</th> <th>Qty</th> <th>UOM</th> </tr> </thead> <tbody> <tr> <td>0H7529A0</td> <td>XB69- XV EXTERNAL GLASS HOLDING PROFILE</td> <td>2.000</td> <td>PC</td> </tr> <tr> <td>VT1255A0</td> <td>XB69- XC59- EXTERNAL GLASS</td> <td>1.000</td> <td>PC</td> </tr> <tr> <td>0H6571A1</td> <td>XB69- XV EXTERNAL GLASS HOLDING PROFILE</td> <td>2.000</td> <td>PC</td> </tr> <tr> <td>VT1255A0</td> <td>XB69- XC59- EXTERNAL GLASS</td> <td>1.000</td> <td>PC</td> </tr> </tbody> </table>	Code	Description	Qty	UOM	0H7529A0	XB69- XV EXTERNAL GLASS HOLDING PROFILE	2.000	PC	VT1255A0	XB69- XC59- EXTERNAL GLASS	1.000	PC	0H6571A1	XB69- XV EXTERNAL GLASS HOLDING PROFILE	2.000	PC	VT1255A0	XB69- XC59- EXTERNAL GLASS	1.000	PC
Code	Description	Qty	UOM																						
0H7529A0	XB69- XV EXTERNAL GLASS HOLDING PROFILE	2.000	PC																						
VT1255A0	XB69- XC59- EXTERNAL GLASS	1.000	PC																						
0H6571A1	XB69- XV EXTERNAL GLASS HOLDING PROFILE	2.000	PC																						
VT1255A0	XB69- XC59- EXTERNAL GLASS	1.000	PC																						



COMPONENT			SPARE PART																																																																										
Code	Description	Image	Code	Description	Kit components																																																																								
VT1255A	XB69- XC59- EXTERNAL GLASS		KDR1279A	XB69/695/613G LED COMPLETE DOOR KIT	<table border="1"> <thead> <tr> <th>Code</th> <th>Description</th> <th>Qty</th> <th>UOM</th> </tr> </thead> <tbody> <tr> <td>0H7529A0</td> <td>XB69- XV EXTERNAL GLASS HOLDING PROFILE</td> <td>2.000</td> <td>PC</td> </tr> <tr> <td>CR1085A0</td> <td>INTERNAL GLASS UPPER HINGE</td> <td>2.000</td> <td>PC</td> </tr> <tr> <td>CR1086A0</td> <td>INTERNAL GLASS LOWER HINGE</td> <td>2.000</td> <td>PC</td> </tr> <tr> <td>GN1181A0</td> <td>INTERNAL GLASS HINGE SEAL</td> <td>2.000</td> <td>PC</td> </tr> <tr> <td>LP1044A0</td> <td>LUX LED BAR</td> <td>1.000</td> <td>PC</td> </tr> <tr> <td>MG1030B2</td> <td>CT-BT DOOR HANDLE</td> <td>1.000</td> <td>PC</td> </tr> <tr> <td>TB2384B0</td> <td>BAKERLUX CHEFLUX DOOR UPPER LISTEL</td> <td>1.000</td> <td>PC</td> </tr> <tr> <td>TB2404A0</td> <td>BAKERLUX CHEFLUX DOOR LOWER LISTEL</td> <td>1.000</td> <td>PC</td> </tr> <tr> <td>TB3092A0</td> <td>6TRAY BAKERTOP LEFT DOOR COLUMN</td> <td>1.000</td> <td>PC</td> </tr> <tr> <td>TB3096A0</td> <td>6TRAY BAKERTOP RIGHT DOOR COLUMN</td> <td>1.000</td> <td>PC</td> </tr> <tr> <td>VE1030A1</td> <td>MAGNET FOR DOOR MICROSWITC H D=22,9mm</td> <td>2.000</td> <td>PC</td> </tr> <tr> <td>VI0239A1</td> <td>SELF-TAPPIN G SCREW 4.2X25 TCB+ INOX</td> <td>4.000</td> <td>PC</td> </tr> <tr> <td>VI1070A0</td> <td>SCREW M4x16 TSP/UNI7688 INOX</td> <td>2.000</td> <td>PC</td> </tr> <tr> <td>VI1075A0</td> <td>NUT M4 H=4 UNI5587 INOX</td> <td>2.000</td> <td>PC</td> </tr> <tr> <td>VI1220A1</td> <td>4,2x12 TCB SELF-TAPPIN G SCREW</td> <td>20.000</td> <td>PC</td> </tr> <tr> <td>VI1300A0</td> <td>SCREW M6X12 T1/2T+INOX</td> <td>12.000</td> <td>PC</td> </tr> <tr> <td>VI1310A0</td> <td>ZINC THREAD INSERT M6 FTR/E</td> <td>8.000</td> <td>PC</td> </tr> </tbody> </table>	Code	Description	Qty	UOM	0H7529A0	XB69- XV EXTERNAL GLASS HOLDING PROFILE	2.000	PC	CR1085A0	INTERNAL GLASS UPPER HINGE	2.000	PC	CR1086A0	INTERNAL GLASS LOWER HINGE	2.000	PC	GN1181A0	INTERNAL GLASS HINGE SEAL	2.000	PC	LP1044A0	LUX LED BAR	1.000	PC	MG1030B2	CT-BT DOOR HANDLE	1.000	PC	TB2384B0	BAKERLUX CHEFLUX DOOR UPPER LISTEL	1.000	PC	TB2404A0	BAKERLUX CHEFLUX DOOR LOWER LISTEL	1.000	PC	TB3092A0	6TRAY BAKERTOP LEFT DOOR COLUMN	1.000	PC	TB3096A0	6TRAY BAKERTOP RIGHT DOOR COLUMN	1.000	PC	VE1030A1	MAGNET FOR DOOR MICROSWITC H D=22,9mm	2.000	PC	VI0239A1	SELF-TAPPIN G SCREW 4.2X25 TCB+ INOX	4.000	PC	VI1070A0	SCREW M4x16 TSP/UNI7688 INOX	2.000	PC	VI1075A0	NUT M4 H=4 UNI5587 INOX	2.000	PC	VI1220A1	4,2x12 TCB SELF-TAPPIN G SCREW	20.000	PC	VI1300A0	SCREW M6X12 T1/2T+INOX	12.000	PC	VI1310A0	ZINC THREAD INSERT M6 FTR/E	8.000	PC
Code	Description	Qty	UOM																																																																										
0H7529A0	XB69- XV EXTERNAL GLASS HOLDING PROFILE	2.000	PC																																																																										
CR1085A0	INTERNAL GLASS UPPER HINGE	2.000	PC																																																																										
CR1086A0	INTERNAL GLASS LOWER HINGE	2.000	PC																																																																										
GN1181A0	INTERNAL GLASS HINGE SEAL	2.000	PC																																																																										
LP1044A0	LUX LED BAR	1.000	PC																																																																										
MG1030B2	CT-BT DOOR HANDLE	1.000	PC																																																																										
TB2384B0	BAKERLUX CHEFLUX DOOR UPPER LISTEL	1.000	PC																																																																										
TB2404A0	BAKERLUX CHEFLUX DOOR LOWER LISTEL	1.000	PC																																																																										
TB3092A0	6TRAY BAKERTOP LEFT DOOR COLUMN	1.000	PC																																																																										
TB3096A0	6TRAY BAKERTOP RIGHT DOOR COLUMN	1.000	PC																																																																										
VE1030A1	MAGNET FOR DOOR MICROSWITC H D=22,9mm	2.000	PC																																																																										
VI0239A1	SELF-TAPPIN G SCREW 4.2X25 TCB+ INOX	4.000	PC																																																																										
VI1070A0	SCREW M4x16 TSP/UNI7688 INOX	2.000	PC																																																																										
VI1075A0	NUT M4 H=4 UNI5587 INOX	2.000	PC																																																																										
VI1220A1	4,2x12 TCB SELF-TAPPIN G SCREW	20.000	PC																																																																										
VI1300A0	SCREW M6X12 T1/2T+INOX	12.000	PC																																																																										
VI1310A0	ZINC THREAD INSERT M6 FTR/E	8.000	PC																																																																										



PLATON SERVICE
8 (800) 500-34-47
www.platonservice.com



COMPONENT			SPARE PART																																																																						
Code	Description	Image	Code	Description	Kit components																																																																				
VT1255A	XB69- XC59- EXTERNAL GLASS		KDR1279A	XB693/695/613G LED COMPLETE DOOR KIT	<table border="1"> <thead> <tr> <th>Code</th> <th>Description</th> <th>Qty</th> <th>UOM</th> </tr> </thead> <tbody> <tr> <td>VI1340A0</td> <td>M6 ST. STEEL THREADED INSERT</td> <td>4.000</td> <td>PC</td> </tr> <tr> <td>VI1810A0</td> <td>M6X6 STAINLESS STEEL FLATHEAD SCREW</td> <td>6.000</td> <td>PC</td> </tr> <tr> <td>VM1490A0</td> <td>CHEFTOP/BAK ERTOP HANDLE SCREWS COVER</td> <td>2.000</td> <td>PC</td> </tr> <tr> <td>VM1510A0</td> <td>XBC/XVC GROOVED DOOR PIN BUSHING</td> <td>1.000</td> <td>PC</td> </tr> <tr> <td>VM1511A0</td> <td>XBC/XVC SLEEK DOOR PIN BUSHING</td> <td>1.000</td> <td>PC</td> </tr> <tr> <td>VM1620A0</td> <td>LED BAR LOWER SUPPORT</td> <td>1.000</td> <td>PC</td> </tr> <tr> <td>VM1621A0</td> <td>LED BAR UPPER SUPPORT</td> <td>1.000</td> <td>PC</td> </tr> <tr> <td>VM1680A0</td> <td>INTERNAL GLASS HINGE</td> <td>2.000</td> <td>PC</td> </tr> <tr> <td>VM1976A0</td> <td>CL BL DOOR COLUMN BLANKING CA</td> <td>2.000</td> <td>PC</td> </tr> <tr> <td>VM1977A0</td> <td>CL BL DOOR UPPER FULCRUM-CA</td> <td>1.000</td> <td>PC</td> </tr> <tr> <td>VM1978A0</td> <td>CL BL DOOR LOWER FULCRUM-CA</td> <td>1.000</td> <td>PC</td> </tr> <tr> <td>VM2000A0</td> <td>M4 SOCKET HEAD SCREW COVER</td> <td>6.000</td> <td>PC</td> </tr> <tr> <td>VM2042A0</td> <td>INTERNAL GLASS LATERAL LOCKING SYSTEM</td> <td>2.000</td> <td>PC</td> </tr> <tr> <td>VM2043A0</td> <td>UPPER - LOWER GLASS SUPPORT</td> <td>2.000</td> <td>PC</td> </tr> <tr> <td>VT1135A0</td> <td>743x620x6 INNER GLASS</td> <td>1.000</td> <td>PC</td> </tr> <tr> <td>VT1255A0</td> <td>XB69- XC59- EXTERNAL GLASS</td> <td>1.000</td> <td>PC</td> </tr> </tbody> </table>	Code	Description	Qty	UOM	VI1340A0	M6 ST. STEEL THREADED INSERT	4.000	PC	VI1810A0	M6X6 STAINLESS STEEL FLATHEAD SCREW	6.000	PC	VM1490A0	CHEFTOP/BAK ERTOP HANDLE SCREWS COVER	2.000	PC	VM1510A0	XBC/XVC GROOVED DOOR PIN BUSHING	1.000	PC	VM1511A0	XBC/XVC SLEEK DOOR PIN BUSHING	1.000	PC	VM1620A0	LED BAR LOWER SUPPORT	1.000	PC	VM1621A0	LED BAR UPPER SUPPORT	1.000	PC	VM1680A0	INTERNAL GLASS HINGE	2.000	PC	VM1976A0	CL BL DOOR COLUMN BLANKING CA	2.000	PC	VM1977A0	CL BL DOOR UPPER FULCRUM-CA	1.000	PC	VM1978A0	CL BL DOOR LOWER FULCRUM-CA	1.000	PC	VM2000A0	M4 SOCKET HEAD SCREW COVER	6.000	PC	VM2042A0	INTERNAL GLASS LATERAL LOCKING SYSTEM	2.000	PC	VM2043A0	UPPER - LOWER GLASS SUPPORT	2.000	PC	VT1135A0	743x620x6 INNER GLASS	1.000	PC	VT1255A0	XB69- XC59- EXTERNAL GLASS	1.000	PC
					Code	Description	Qty	UOM																																																																	
					VI1340A0	M6 ST. STEEL THREADED INSERT	4.000	PC																																																																	
					VI1810A0	M6X6 STAINLESS STEEL FLATHEAD SCREW	6.000	PC																																																																	
					VM1490A0	CHEFTOP/BAK ERTOP HANDLE SCREWS COVER	2.000	PC																																																																	
					VM1510A0	XBC/XVC GROOVED DOOR PIN BUSHING	1.000	PC																																																																	
					VM1511A0	XBC/XVC SLEEK DOOR PIN BUSHING	1.000	PC																																																																	
					VM1620A0	LED BAR LOWER SUPPORT	1.000	PC																																																																	
					VM1621A0	LED BAR UPPER SUPPORT	1.000	PC																																																																	
					VM1680A0	INTERNAL GLASS HINGE	2.000	PC																																																																	
					VM1976A0	CL BL DOOR COLUMN BLANKING CA	2.000	PC																																																																	
					VM1977A0	CL BL DOOR UPPER FULCRUM-CA	1.000	PC																																																																	
					VM1978A0	CL BL DOOR LOWER FULCRUM-CA	1.000	PC																																																																	
					VM2000A0	M4 SOCKET HEAD SCREW COVER	6.000	PC																																																																	
					VM2042A0	INTERNAL GLASS LATERAL LOCKING SYSTEM	2.000	PC																																																																	
					VM2043A0	UPPER - LOWER GLASS SUPPORT	2.000	PC																																																																	
					VT1135A0	743x620x6 INNER GLASS	1.000	PC																																																																	
VT1255A0	XB69- XC59- EXTERNAL GLASS	1.000	PC																																																																						

PLATON SERVICE
8 (800) 500-34-47
www.platonservice.com



ASM4101A/0.D01 - General overview

FRONT

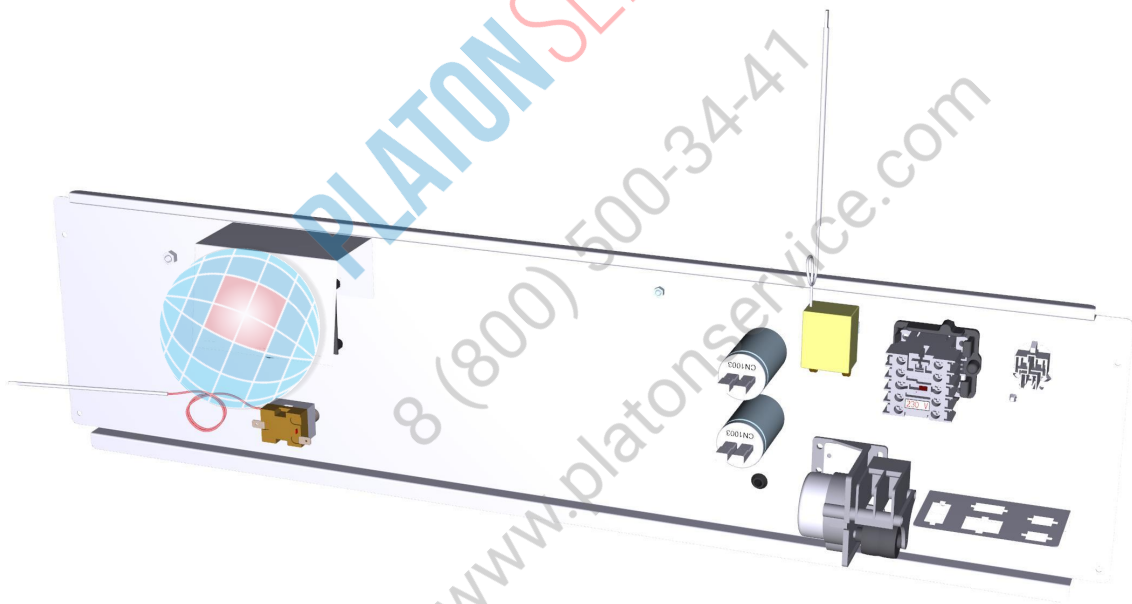



ASM4101A/0.D01 - General overview

REAR

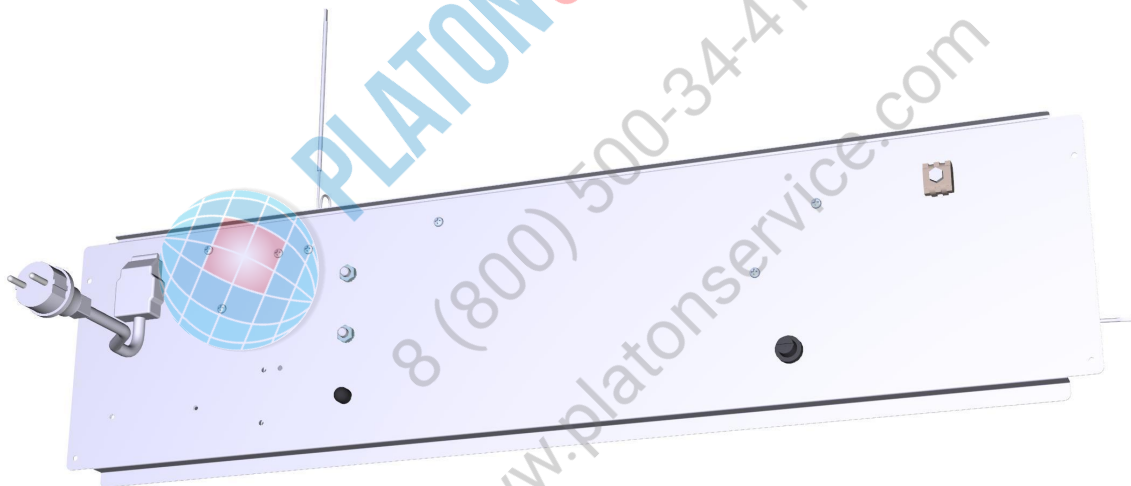





COMPONENT			SPARE PART																		
Code	Description	Image	Code	Description	Kit components																
0H6574B	LUX GAS COMPONENTS HOLDER		0H6574B0	LUX GAS COMPONENTS HOLDER																	
0H6769A	CONNECTOR FIXING PANEL		0H6769B0	CONNECTOR FIXING PANEL																	
VE1615A	MOTOR REVERSING SWITCH		KVE1615A	MOTOR REVERSING SWITCH KIT	<table border="1"> <thead> <tr> <th>Code</th> <th>Description</th> <th>Qty</th> <th>UOM</th> </tr> </thead> <tbody> <tr> <td>0H1429A0</td> <td>VE1615A INVERTER FIXING PLATE</td> <td>1.000</td> <td>PC</td> </tr> <tr> <td>VE1615A0</td> <td>MOTOR REVERSING SWITCH</td> <td>1.000</td> <td>PC</td> </tr> <tr> <td>VI1960A1</td> <td>4.2X9.5 CROSS ZN-NI SELF-THREADING SCREW</td> <td>3.000</td> <td>PC</td> </tr> </tbody> </table>	Code	Description	Qty	UOM	0H1429A0	VE1615A INVERTER FIXING PLATE	1.000	PC	VE1615A0	MOTOR REVERSING SWITCH	1.000	PC	VI1960A1	4.2X9.5 CROSS ZN-NI SELF-THREADING SCREW	3.000	PC
Code	Description	Qty	UOM																		
0H1429A0	VE1615A INVERTER FIXING PLATE	1.000	PC																		
VE1615A0	MOTOR REVERSING SWITCH	1.000	PC																		
VI1960A1	4.2X9.5 CROSS ZN-NI SELF-THREADING SCREW	3.000	PC																		
VE1115A	20 A 230V 4 POLES MINICONTACTOR		KVE1115A	20A 230V 4 POLES MINICONTACTOR KIT	<table border="1"> <thead> <tr> <th>Code</th> <th>Description</th> <th>Qty</th> <th>UOM</th> </tr> </thead> <tbody> <tr> <td>VE1115A0</td> <td>20 A 230V 4 POLES MINICONTACTOR</td> <td>1.000</td> <td>PC</td> </tr> <tr> <td>VM1075A1</td> <td>PLASTIC CLIP TO FIX CONTACTORS</td> <td>4.000</td> <td>PC</td> </tr> </tbody> </table>	Code	Description	Qty	UOM	VE1115A0	20 A 230V 4 POLES MINICONTACTOR	1.000	PC	VM1075A1	PLASTIC CLIP TO FIX CONTACTORS	4.000	PC				
Code	Description	Qty	UOM																		
VE1115A0	20 A 230V 4 POLES MINICONTACTOR	1.000	PC																		
VM1075A1	PLASTIC CLIP TO FIX CONTACTORS	4.000	PC																		
VM1056A	SMALL CONTACTOR BRACKET VE1115A		VM1056A0	SMALL CONTACTOR BRACKET VE1115A																	

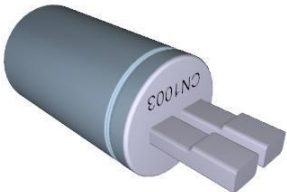
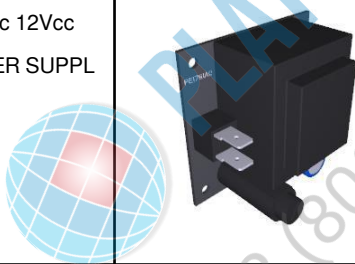

COMPONENT			SPARE PART																										
Code	Description	Image	Code	Description	Kit components																								
CN1003A	6,3 Uf MOTOR CAPACITOR		KCN1003A	6,3 uF MOTOR CAPACITOR KIT	<table border="1"> <thead> <tr> <th>Code</th> <th>Description</th> <th>Qty</th> <th>UOM</th> </tr> </thead> <tbody> <tr> <td>CN1003A0</td> <td>6,3 Uf MOTOR CAPACITOR</td> <td>1.000</td> <td>PC</td> </tr> <tr> <td>VI1931A0</td> <td>M8x1.65 H4 CH13 ZINC PLATED NUT</td> <td>1.000</td> <td>PC</td> </tr> <tr> <td>VI1932A0</td> <td>D8 INDENTED ZINC PLATED WASHER</td> <td>1.000</td> <td>PC</td> </tr> </tbody> </table>	Code	Description	Qty	UOM	CN1003A0	6,3 Uf MOTOR CAPACITOR	1.000	PC	VI1931A0	M8x1.65 H4 CH13 ZINC PLATED NUT	1.000	PC	VI1932A0	D8 INDENTED ZINC PLATED WASHER	1.000	PC								
Code	Description	Qty	UOM																										
CN1003A0	6,3 Uf MOTOR CAPACITOR	1.000	PC																										
VI1931A0	M8x1.65 H4 CH13 ZINC PLATED NUT	1.000	PC																										
VI1932A0	D8 INDENTED ZINC PLATED WASHER	1.000	PC																										
MR1000A	CABLE 3x1,5 H07RN-F MT1,5+K2/3+SCHUK		KMR1000A	KIT CABLE 3X1,5 H07RN-F +K2/3+SCHUKO	<table border="1"> <thead> <tr> <th>Code</th> <th>Description</th> <th>Qty</th> <th>UOM</th> </tr> </thead> <tbody> <tr> <td>MR1000A0</td> <td>CABLE 3x1,5 H07RN-F MT1,5+K2/3+S CHUKO</td> <td>1.000</td> <td>PC</td> </tr> </tbody> </table>	Code	Description	Qty	UOM	MR1000A0	CABLE 3x1,5 H07RN-F MT1,5+K2/3+S CHUKO	1.000	PC																
Code	Description	Qty	UOM																										
MR1000A0	CABLE 3x1,5 H07RN-F MT1,5+K2/3+S CHUKO	1.000	PC																										
PE1782A	200-240Vac 12Vcc 6VA POWER SUPPL		KPE1782A	LED BAR 200-240Vac 12Vcc TRANSFORMER KIT	<table border="1"> <thead> <tr> <th>Code</th> <th>Description</th> <th>Qty</th> <th>UOM</th> </tr> </thead> <tbody> <tr> <td>PE1782A0</td> <td>200-240Vac 12Vcc 6VA POWER SUPPLY</td> <td>1.000</td> <td>PC</td> </tr> <tr> <td>VM1745A0</td> <td>CARD SUPPORT</td> <td>4.000</td> <td>PC</td> </tr> </tbody> </table>	Code	Description	Qty	UOM	PE1782A0	200-240Vac 12Vcc 6VA POWER SUPPLY	1.000	PC	VM1745A0	CARD SUPPORT	4.000	PC												
Code	Description	Qty	UOM																										
PE1782A0	200-240Vac 12Vcc 6VA POWER SUPPLY	1.000	PC																										
VM1745A0	CARD SUPPORT	4.000	PC																										
TR1136A	318°C -0/+24 1 POLE SAFETY THERMOSTAT		KTR1136A	318°C -0/+24 SAFETY THERMOSTAT KIT	<table border="1"> <thead> <tr> <th>Code</th> <th>Description</th> <th>Qty</th> <th>UOM</th> </tr> </thead> <tbody> <tr> <td>0H7030A0</td> <td>THERMOSTAT BULB INLET COVER</td> <td>1.000</td> <td>PC</td> </tr> <tr> <td>GN1531A0</td> <td>THERMOSTAT BULB INLET SEALING</td> <td>1.000</td> <td>PC</td> </tr> <tr> <td>SL1045A0</td> <td>S57 BLACK SILICONE - 80ml CARTRIDGE</td> <td>1.000</td> <td>PC</td> </tr> <tr> <td>TR1136A0</td> <td>318°C -0/+24 1 POLE SAFETY THERMOSTAT</td> <td>1.000</td> <td>PC</td> </tr> <tr> <td>VI1220A1</td> <td>4,2x12 TCB SELF-TAPPIN G SCREW</td> <td>3.000</td> <td>PC</td> </tr> </tbody> </table>	Code	Description	Qty	UOM	0H7030A0	THERMOSTAT BULB INLET COVER	1.000	PC	GN1531A0	THERMOSTAT BULB INLET SEALING	1.000	PC	SL1045A0	S57 BLACK SILICONE - 80ml CARTRIDGE	1.000	PC	TR1136A0	318°C -0/+24 1 POLE SAFETY THERMOSTAT	1.000	PC	VI1220A1	4,2x12 TCB SELF-TAPPIN G SCREW	3.000	PC
Code	Description	Qty	UOM																										
0H7030A0	THERMOSTAT BULB INLET COVER	1.000	PC																										
GN1531A0	THERMOSTAT BULB INLET SEALING	1.000	PC																										
SL1045A0	S57 BLACK SILICONE - 80ml CARTRIDGE	1.000	PC																										
TR1136A0	318°C -0/+24 1 POLE SAFETY THERMOSTAT	1.000	PC																										
VI1220A1	4,2x12 TCB SELF-TAPPIN G SCREW	3.000	PC																										

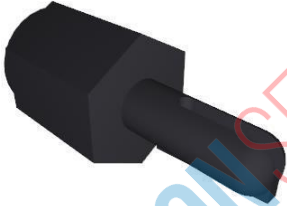

COMPONENT			SPARE PART														
Code	Description	Image	Code	Description	Kit components												
TR1142A	EXHAUST FUMES THERMOSTAT		KTR1142A	EXHAUST FUMES THERMOSTAT KIT	<table border="1"> <thead> <tr> <th>Code</th> <th>Description</th> <th>Qty</th> <th>UOM</th> </tr> </thead> <tbody> <tr> <td>TR1142A0</td> <td>EXHAUST FUMES THERMOSTAT</td> <td>1.000</td> <td>PC</td> </tr> </tbody> </table>	Code	Description	Qty	UOM	TR1142A0	EXHAUST FUMES THERMOSTAT	1.000	PC				
Code	Description	Qty	UOM														
TR1142A0	EXHAUST FUMES THERMOSTAT	1.000	PC														
VM1745A	CARD SUPPORT		KVM1745A	BOARD SUPPORT 10 PCS KIT	<table border="1"> <thead> <tr> <th>Code</th> <th>Description</th> <th>Qty</th> <th>UOM</th> </tr> </thead> <tbody> <tr> <td>VM1745A0</td> <td>CARD SUPPORT</td> <td>10.000</td> <td>PC</td> </tr> </tbody> </table>	Code	Description	Qty	UOM	VM1745A0	CARD SUPPORT	10.000	PC				
Code	Description	Qty	UOM														
VM1745A0	CARD SUPPORT	10.000	PC														
VM1750A	BRASS COMB CLAMP		KVM1750A	COMB TERMINAL BLOCK KIT	<table border="1"> <thead> <tr> <th>Code</th> <th>Description</th> <th>Qty</th> <th>UOM</th> </tr> </thead> <tbody> <tr> <td>VI1040A0</td> <td>INDENTED INTERNAL WASHER D=6 ZN</td> <td>2.000</td> <td>PC</td> </tr> <tr> <td>VM1750A0</td> <td>BRASS COMB CLAMP</td> <td>1.000</td> <td>PC</td> </tr> </tbody> </table>	Code	Description	Qty	UOM	VI1040A0	INDENTED INTERNAL WASHER D=6 ZN	2.000	PC	VM1750A0	BRASS COMB CLAMP	1.000	PC
Code	Description	Qty	UOM														
VI1040A0	INDENTED INTERNAL WASHER D=6 ZN	2.000	PC														
VM1750A0	BRASS COMB CLAMP	1.000	PC														